

TOSHIBA

STEREO CASSETTE DECK

PC-G90AD

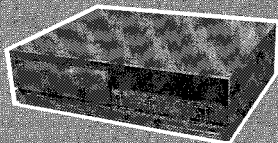

SPECIFICATIONS

Heads:	Record: Super AP Playback: 12-plate laminated Super AP Erase: AF 1/2 gap ferrite head	SN Ratio:	60 dB (peak level, WTD, chrome position tape)
Drive System:	2-motor IC logic control	Total Distortion:	0.5% (300 Hz, 0 dB chrome position tape)
Motors:	DC servo motor for caustan drive DC motor for reel drive DC motor for control	Bias Frequency:	85 kHz
Tape Speed:	4.8 cm/sec.	Input Terminals:	MIC: 0.25mV (500 ohm) 10k ohm
Wow & Flutter:	0.022% WBMS, $\pm 0.08\%$ DIN	Output Terminals:	LINE: 70mV (50k ohm) LINE: 0.4V (50k ohm) Headphones: 1mV (8 ohm)
Fast Forward and Rewind Time:	Approx. 75 sec. (60 tape)	Power Supply:	AC 220V \pm 50 Hz (for Europe) AC 240V \pm 50 Hz (for the U.K. and Australia)
Frequency Response:	20 - 21,000 Hz with metal tape and -20 dB input 20 - 20,000 Hz with chrome position tape and -20 dB input 20 - 18,000 Hz with normal tape and -20 dB input	Power Consumption:	32W
		Major Dimensions:	420(W) x 120(H) x 321(D) mm (including front panel knobs, etc. and rubber supports)
		Weight:	6.7 kg

Specifications are subject to change without notice.

TE, TU

PRINTED IN JAPAN 22905183 March, 1983 

CONTENTS

1. BLOCK DIAGRAM	2
2. OPERATING INSTRUCTIONS	3 to 9
3. DISASSEMBLY INSTRUCTIONS	10 to 11
4. ADJUSTING PARTS LOCATIONS	12
5. ADJUSTMENT INSTRUCTIONS	13 to 15
6. VOLTAGE CHART	16 to 17
7. ELECTRICAL PARTS LOCATIONS	18 to 21
8. SCHEMATIC DIAGRAM	22
9-1. EXPLODED VIEW MECHANISM	23
9-2. MECHANISM PARTS LIST	24
10-1. EXPLODED VIEW CABINET	25
10-2. CABINET PARTS LIST	26
11. PARTS LIST	27 to 36

1. BLOCK DIAGRAM

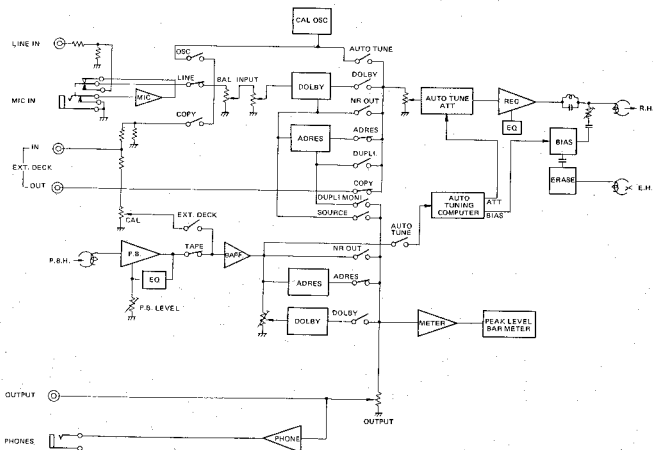

Figure 1

2. OPERATING CONTROLS

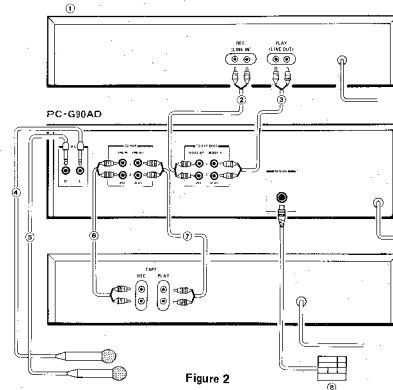
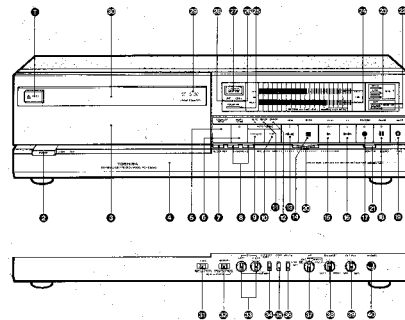

Figure 2

FEATURES

- DD Motor Driven Closed Loop Dual Capstan System**
 Both capstans are driven by separate low-speed DD motors to greatly improve the drive system for high performance in tape travel. The wow & flutter rating in this "simply & silent" mechanism is only 0.022% WRMS.
- New Super-AP Three Head Configuration**

- New "Double Gates" IC**
 With further improvements to the dynamic characteristics gained by incorporating a "variable attack" type level sensor, the **Dolby NR** system developed by Toshiba has now been adapted to comply with digital requirements while maintaining full compatibility with conventional **Dolby NR** systems.

■ Computerized Auto Tape Tuning System

Optimum bias and sensitivity are adjusted automatically by built-in computer.

■ Locks Unit Function (with Copy Switch)

The PC-G90AD also includes a four-channel **locks** unit function. This also enables the PC-G90AD to be used as an **locks** unit in connection with other tape decks. With the second deck connected to the unit terminals, pressing the COPY switch enables direct tape dubbing from the other deck.

FRONT PANEL CONTROLS

① [▲ EJECT] Button

② [POWER] Switch

The peak level meter, the cassette compartment lamp, and the AUTO indicator come on when the [POWER] switch is pressed ON. Note that no tape operations are possible during the first five seconds after the power is switched on. Press the switch a second time to switch off.

③ Cassette Compartment Door

④ Sub-control Panel

Open by pushing downwards on both sides.

⑤ [COUNTER RESET] Switch

For resetting the linear counter to 0:00.

⑥ [INDEX SCAN] Switch

When this switch is pressed during playback mode, the tape is advanced to the start of the next tune in fast forward mode, and approximately 10 seconds of that tune is played. The tape then advances in fast forward mode to the start of the next tune after that, and again plays about 10 seconds of the tune, and so on to the end of the tape. If playback of the whole of a particular tune is desired, simply press the playback button.

⑦ [BLOCK REP] (Block Repeat) Switch

When this switch is pressed ON for the block repeat function, B is displayed in the counter (see page 9 for further details).

⑧ [1-MEMO-2] Block Repeat

When the block repeat function is used, 1-MEMO is the memory position for automatic playback, and 2-MEMO the memory position for automatic rewind.

⑨ and ⑩ [AUTO TUNING]

⑨ [FIX/AUTO]

Press once for AUTO (whereupon the AUTO indicator comes on), and press again for FIX (normal status).

⑩ [START]

Press this button for automatic tape bias and sens sensitivity adjustments (which take 10 to 15 seconds).

■ Direct-Coupled Dual FET Input Head Amplifier

■ Easy-to-read Fluorescent Tube Level Meter

■ Linear Electronic Counter (with Block Repeat Function)

Based on the basis of the rotational speed of both reels, the tape travel time is computed and displayed by micro-computer.

■ MOSS, Index Scan, and Memory Counter Functions

① [READY]

Blinks on and off during tape tuning operation, and remains on to indicate previous presetting in memory.

② [ERROR] Indicator Lamp

Comes on if an error occurs during auto tape tuning.

Tape Mode Control Buttons (③ thru ⑩)

③ [◀ REW] (Rewind) Button

④ [■ STOP] Button

⑤ [▶ PLAY] Button

⑥ [▶▶ FF] (Fast Forward) Button

⑦ [● RECORD] Button

Recording mode is set by pressing this button together with the [▶ PLAY] button. And if the [■ PAUSE] button is pressed while pressing this [● RECORD] button, the deck is put into recording standby mode.

Note that recording mode cannot be set when no cassette tape has been loaded, and when the erasure prevention tabs have been removed.

⑧ [II PAUSE] Button

When this button is pressed during playback or recording mode, the tape is halted temporarily in that mode. This pause state is released by pressing the [▶ PLAY] button.

⑨ [○ MUTE] (Recording Mute) Button

Used to from five second intervals of blank tape. Recording mute mode is switched automatically to pause mode after five seconds.

⑩ [INPUT LEVEL] Adjustment Control

For adjusting the input level. Left/right balance is adjusted by the BALANCE control in the subcontrol panel.

⑪ [MONITOR] Switch

Switch for selecting the monitor (output) signal.

< SOURCE >

Position for monitoring the input (recording) signal applied to this tape deck.

< TAPE >

Position for monitoring recorded signals (playback program). Recording performance can be monitored simultaneously in this position.

⑫ [SOURCE/TAPE] Monitor Indicator Lamps

⑬ [NORMAL/CrO₂ (Chrome)/METAL] Tape Indicator Lamps

⑭ Level Meter

Peak level display of the input signal to be recorded, and the level of signals recorded on tape.

⑮ [DOLBY* NR] Indicator Lamp

⑯ [COPY] Indicator Lamp

⑰ [locks] Indicator Lamp

⑱ [UNIT] Indicator Lamp

⑲ [LINEAR COUNTER]

This time counter increases in one second steps. In rewind and fast forward modes, too, the time corresponding to the playback mode time is displayed. The display includes two digits for minutes, and two digits for seconds.

< B > Block repeat

< 1 > Memory 1

< 2 > Memory 2

⑳ Cassette Compartment Lamp

This lamp enables easy check of the remaining amount of tape.

㉑ [TIMER] Standby Switch

Switch for preset recording and morning alarm playback when an optional audio timer is used, and also automatic repeated playback. The switch is normally left in the OFF position.

㉒ [MEMORY] Counter Switch

Switch used for automatic stopping of the tape when counter is rewound to 0:00, followed by automatic start of playback mode from that position. Also used for automatic repeated playback. (The counter may not always stop exactly at 0:00.)

㉓ [locks CAL] (locks Calibration) Control

Control for adjusting to the locks reference level when the deck is used as an locks unit. The control is not used when the PC-G90AD is operated in recording or playback mode.

㉔ [EXT DECK (UNIT)] locks Unit Switch

Used in locks recording or playback mode with another cassette tape deck.

㉕ [COPY] Switch

Used when recording from another tape deck.

㉖ [MPX FIL] (MPX Filter) Switch

Used when recording FM stereo broadcasts or TV multiplex programmes.

㉗ NR Noise Reduction Switch

< □□ > DOLBY* NR

Set to this position for Dolby NR recording and playback.

< OUT >

Set to this position when not using any noise reduction system.

< locks >

Set to this position for locks recording and playback.

In this position, the epoch-making automatic dynamic range expansion system capable of recording and playback of fresh, natural sounds with practically negligible tape hiss across the entire frequency spectrum is switched on.

The locks indicator lamp comes on in this position.

< DUPLI > (locks Duplicator) Switch

Switch used to enable monitoring of normal sounds during tape dubbing of locks encoded tapes from another tape deck.

< OSC > Built-in Oscillator (Signal Generator)

Set to this position for level adjustment when recording with locks NR in another tape deck.

㉘ [BALANCE] Adjustment Control

Left/right adjustment of input level.

㉙ [OUTPUT] Level Adjustment Control

Adjustment of the output (monitor) level of the playback signal from this tape deck. The headphones level is also adjusted at the same time.

㉚ [PHONES] (Headphones) Jack

* Noise reduction system manufactured under license from Dolby Laboratories Licensing Corporation. "Dolby" and the double-D symbol are trademarks of Dolby Laboratories Licensing Corporation.

CONNECTIONS

Make sure that each cable is connected to the correct terminal, and that all connections are made securely.

- Make sure that the power switches of all components are off before making any connections.
- Make doubly sure that there are no loose connections anywhere since these can easily give rise to unwanted noise.
- Use the red plug for the right channel.
- When connecting to the other tape deck, use the connecting cables supplied with that deck.

① Another tape deck (external deck).

② Connecting cable for recording (supplied with other tape deck, or purchased separately).

③ Connecting cable for playback (also supplied with other tape deck, or purchased separately).

④ Left channel microphone (optional).

⑤ Right channel microphone (optional).

⑥ Connecting cable for recording.

⑦ Connecting cable for playback.

⑧ RM-20S (optional).

AUTO TAPE SELECTION AND AUTO TAPE TUNING (ATTS)

The PC-G90AD is designed to detect tape type (normal, chrome, or metal), and set bias and equalization levels automatically when the cassette tape is loaded. (The results are displayed immediately by the respective indicator lamps. Note, however, that detection may not

be possible if an old-type tape is used.)

The deck also features an auto tuning mechanism which automatically sets the optimum bias and sensitivity for each type of tape. This mechanism is incorporated in a special microcomputer.

Operation

Note: Set to FIX when not recording.

■ Input of New Data

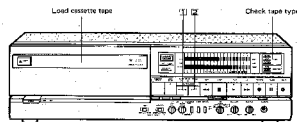

Figure 3

● Load the tape and check the type of tape.

- Press **FIX/AUTO** — The [AUTO] indicator lamp comes on. (This lamp comes on when the [POWER] switch is switched ON, and if the [READY] indicator lamp also comes on at that time, it shows that data has already been stored in memory.)
- ATTS start: Press **START** — The [READY] indicator lamp lights up (indicating that the ATTS signal is being recorded).
- ATTS end: **STOP** — **REW** — **STOP** — If the [READY] indicator comes on,
 - tape characteristics data obtained by ATTS operation is stored in memory by microcomputer.
 - since separate memories are available for each type of tape (NORM, CrO₂, and METAL), characteristics data for each type can be stored in memory.
 If the [ERROR] indicator lamp comes on, either repeat the ATTS operation, or exchange with another cassette tape.

■ Use of Data already Stored in Memory

After checking that both the [AUTO] and [READY] indicator lamps are on, proceed with normal recording mode operation.

■ When [FIX/AUTO] switch is set to FIX

The [AUTO] and [READY] indicator lamps do not come on.

Fixed bias and sensitivity levels are set according to the type of tape detected by the auto tape selector.

Note:

- If non-standard tapes or tapes of poor sensitivity are used, an accurate output cannot be obtained. The ATTS operation is cancelled automatically, and the [ERROR] indicator lamp comes on.
- If the [POWER] switch, an operation mode button, or any other switch is operated during ATTS operation, the ATTS operation is cancelled automatically.
- If the ATTS operation is started near the end of the tape, and the end is subsequently reached before completion of the ATTS operation, the auto stop mechanism is activated and the ATTS operation is cancelled.
- If a second ATTS operation is performed, the tape characteristics data of the first operation is cleared from memory, and the new data is stored instead.
- If the tape selector switch fails to operate correctly due to the absence of a detector hole, use another tape.
- Since the memory contents are preserved for about one day after the power is switched off, the ATTS function can also be used in timer recording.
- Leave the [FIX/AUTO] switch in the FIX position when not using the ATTS function.
- If the [READY] indicator lamp is off with the [AUTO] indicator lamp on, the bias and sensitivity values will be fixed values.

LINEAR ELECTRONIC COUNTER

The linear electronic counter featured in the PC-G90AD displays tape travel time (during playback rewind, and fast forward modes) in minutes and seconds in digital mode. This counter can be used in two different ways.

■ Display of Tape Travel Time

During playback, rewind, and fast forward modes, tape travel is counted (timed) in minutes and seconds.

If the tape is stopped or put into pause mode, the counter also stops. During fast forward and rewind modes, the time corresponding to the length of tape (and equivalent to the playback mode time) is displayed.

- Press the [COUNTER RESET] switch **Ⓢ** at the beginning of the tape (but do not overlook the leader tape).

■ Display of Remaining Time

If the time of the whole tape is displayed as a minus value, the remaining amount of time is shown. This is particularly helpful in recording mode.

- Press the [] FF button **Ⓛ** to advance the tape to the end, and then press the [COUNTER RESET] switch **Ⓢ**. (Also remember that there is leader tape at the end of the tape.) Next press the [] REW button **Ⓜ** to rewind the tape back to the beginning where the counter will display a minus reading. (A display of -30:00 indicates that there is 30 minutes of tape left.)

When recording is started, the counter will proceed to count down. For example, -30:00, -29:59, -29:58, ... thereby showing the remaining amount of time at all times.

Caution:

Counter Precision

- This linear electronic counter is not a clock, and small differences in the displayed time do occur. (The times displayed in playback mode differ slightly from the times displayed in fast forward and rewind modes.)
- This difference varies with different tape types. (Variation also occurs between tapes of the same kind.) The counter has been standardized for C-60 and C-90 tapes. With shorter tapes or tapes with a larger hub diameter, there will be differences from the actual time.
- Although the counter counts in units of seconds, the counting rate may speed up or slow down marginally at times to compensate the counting.

Counter Display

- The counter display also includes MEMO, B, 1, and 2 function displays.

(See page 9 for details on block repeat.)

- Note:**
- Block repeat operation is not possible with minus displays. Always reset the counter at the beginning for block repeat.
 - The 1 and 2 displays cannot be erased when the display is a minus value.
 - To erase the MEMO, 1, and 2 displays, either press the [COUNTER RESET] switch **Ⓢ**, or press the [1-MEMO-2] switch **Ⓣ** when the B display is disappearing.

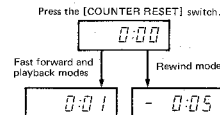

Figure 4

- When rewinding from 0:00, the counter display changes to -0:01, -0:02 and so on.

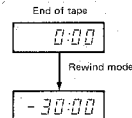

Figure 5

- This method enables the differences in recording times between tapes of different type, length, and brand etc. to be better controlled.

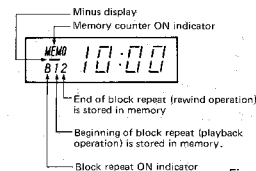
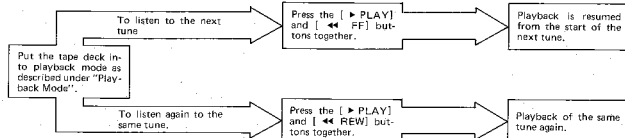

Figure 6

AUTOMATIC TUNE SELECTION (MOSS, INDEX SCAN)

MOSS

- The Music Quick Selector System (MOSS) is used, in playback mode, to automatically locate the start of tunes and enable immediate playback of a particular tune. Thus you can either playback the same tune or proceed to the next tune. The operating procedure is outlined below.



- Note:** The MOSS feature does not function if:—
- The blank portion of tape between tunes is less than 5 seconds.
 - There is noise in the blank portion of tape.
 - There are very quiet passages or long pauses within the tune.
 - The recording level is too low.
 - The fast forward or rewind button is pressed accidentally before pressing the MOSS switch. In this case, the deck will operate in normal fast forward or rewind mode.
 - If the [▶] PLAY and [◀◀] REW buttons are pressed soon after the start of a tune, or if the [▶] PLAY and [▶▶] FF buttons are pressed near the end of a tune, a whole tune is skipped and playback commences from the next tune (in either direction) after that.

Figure 7

Index Scan Playback

If the [INDEX SCAN] switch ④ is pressed during playback mode, the INDEX SCAN indicator lamp comes on, the tape is rewound to the beginning of the recorded program, and playback is resumed for about 10 seconds at that position. The tape then advances to the beginning of each tune in fast forward mode, and automati-

cally plays the first 10 seconds of each tune. If the [▶] PLAY button ① is pressed during one of these 10 second playback periods, the index scan function is cancelled and normal playback mode is resumed. To stop index scanning, simply press the [STOP] button ②.

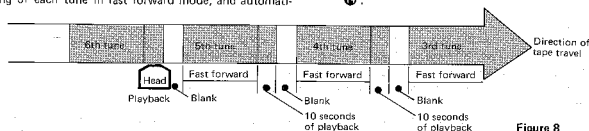

Figure 8

Preparation of Tape for Automatic Tune Selection

(Use of the Auto Mute Button)
Unrecorded sections of a tape are formed in the following way during recording mode to prepare tapes for automatic tune selection.

- Press the [◊] MUTE button ⑩ at the end of the tune being recorded (and release the button again immediately). Approximately five seconds of blank tape is formed, the deck being switched automatically to pause mode (recording standby with the [||] PAUSE button ⑨ indicator lamp on) at the end of the five seconds. (The [▶] PLAY button ① indicator lamp blinks on and off during this recording mute mode.)

Note: Leave the [MONITOR] switch ④ in the < SOURCE > position to enable the source programme to be monitored. (The source programme cannot be monitored in the [MONITOR] switch is in the < TAPE > position.)

- To form a portion of unrecorded tape of more than five seconds, keep the [◊] MUTE button ⑩ depressed.
- To form a portion of unrecorded tape of less than five seconds, press the [||] PAUSE button ⑨ at the desired time after pressing the [◊] MUTE button ⑩.

AUTOMATIC PLAYBACK

The PC-G90AD is capable of various automatic playback operations, these being set by combination of repeat switch, memory switch, and block repeat switch. (Always switch the relevant switches off after the end of the respective operations.)

Tape travel mode	[TIMER] switch ①	[MEMORY] switch ②	[BLOCK REP] switch ③ [1-MEMO-2] switch ④	Operation mode button pressed after switch setting
Memory stop 	OFF	STOP	Note: Turn the block repeat ON display < B > off.	REW button
Memory play 	OFF	PLAY	Note: Turn the block repeat ON display < B > off.	REW button
Auto rewind stop 	PLAY	OFF	Note: Turn the block repeat ON display < B > off.	PLAY button
Auto rewind memory stop 	PLAY	STOP	Note: Turn the block repeat ON display < B > off.	PLAY button
Memory repeat 	PLAY	PLAY	Note: Turn the block repeat ON display < B > off.	REW (or PLAY) button
Block repeat I 	PLAY	PLAY	Note: The block repeat ON display comes on.	REW (or PLAY) button
Block repeat II 	PLAY	PLAY		REW (or PLAY) button
Block repeat III 	PLAY	OFF		REW (or PLAY) button

S : Tape start
E : Tape end
C : Counter zero display (note)

B₁ : Memory 1 (PLAY at this point)
B₂ : Memory 2 (REW at this point)

Note: The C point may not always be exactly at 0:00.
[Example: -0:03]

3. DISASSEMBLY INSTRUCTIONS

CASSETTE COVER REMOVAL

1. Open cassette holder by pushing eject knob.
2. Slide the holder in direction shown by arrow (A), and the holder will be removed.

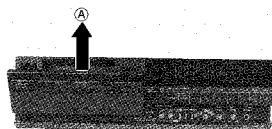

Figure 9

TOP COVER REMOVAL

1. Remove six screws (B), (C), (D), and top cover will be removed.

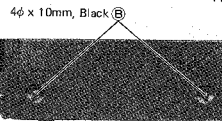

Figure 10

FRONT PANEL ASS'Y REMOVAL WITH MECHA. & P.C. BOARD

1. Remove six screws (E), (F), (G), and front panel assembly will be removed.



Figure 11

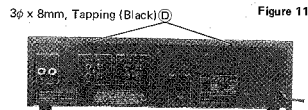

Figure 12

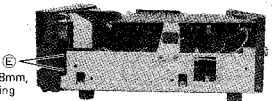

Figure 13

BOTTOM PLATE REMOVAL

1. Remove seven screws (H) and bottom plate will be removed.

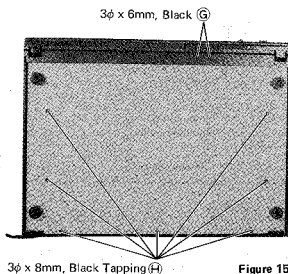

Figure 14

ACCESS TO NR (Noise Reduction) P.C. BOARD

1. Remove two screws (I) and open the P.C. Board and hold it with P.C. Board holder for your convenience in servicing.

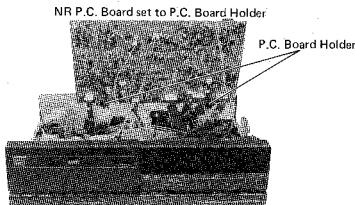

Figure 15

METER P.C. BOARD REMOVAL

1. Remove NR P.C. Board, and remove two screws (J).
2. Remove two screws (K) and remove key board switch connector P.C. Board.
3. Remove one screw (L) at center of Meter P.C. Board, and the P.C. Board can be removed.

Note: Before removing P.C. Board, always remove two counter securing screws (M) to prevent the counter from damage which may be caused by the P.C. Board touched to the counter.

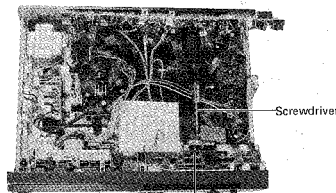

Figure 16

3φ x 10mm, Tapping Screw (Red) (I)
(Tip of screwdriver)

MECHANISM ASSEMBLY REMOVAL

1. Remove four screws (N) (O), and mechanism assembly will be removed.

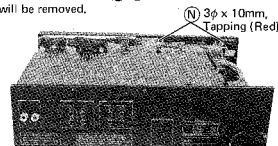

Figure 17

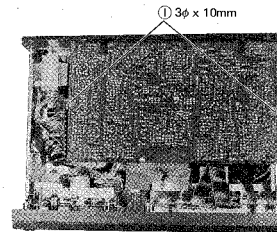

Figure 18

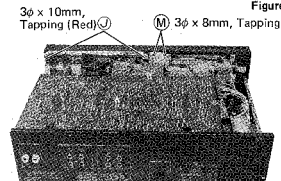

Figure 19

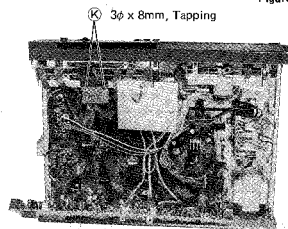

Figure 20

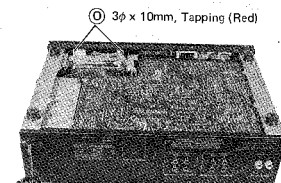

Figure 21

4. ADJUSTING PARTS LOCATION

5. ADJUSTMENT

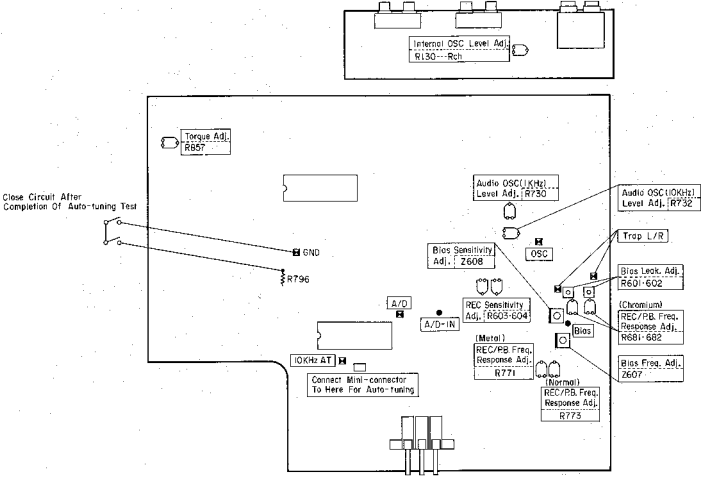

Figure 23

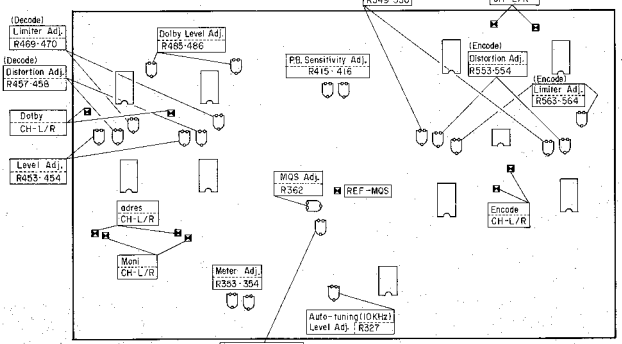

Figure 24

No	Item	Nominal Specs	Test Tape	Volume Control			Switch Position					Adjustment Position	
				REC/BAL	PB	CAL	MONITOR	NR	EXT-DECK	COPY	MPX		
1	Torque Adjustment	50 ±5g-cm	Torque Tape	-	MAX	-	TAPE	OUT	OUT	OUT	OUT	OUT	R857
2	Head Azimuth Adjustment	Maximum	ATT-111	-	-	-							Head Azimuth Adjustment Screw
3	Tape Speed Measurement	3000 ±30 Hz	ATT-111	-	-	-							(Semi-fixed resistor on the Mecha. P.C. Board)
4	Playback Sensitivity Adjustment	580 ±10mV	ATT-150	-	-	-							R415 R416
5	DOLBY DECODE Adjustment												
①	Input Level Adjustment	580 ±10mV	-	-	-	Adjust.		OUT	IN				CAL Volume
②	DECODE Level Adjustment	580 ±10mV	-	-	-	Adjust. Position		DOLBY					R485 R486
6	Address DECODE Adjustment												
①	Input Level Adjustment	300 ±10mV	-	-	-								(CAL Volume)
②	DECODE Level Adjustment	300 ±10mV	-	-	-								R453 R454
③	DECODE Distortion Adjustment	Less than 0.12%	-	-	-								R457 R458
④	DECODE Limiter Adjustment	+ 2 ±0.2 dB	-	-	-								R469 R470
7	Meter Adjustment	AD mark											R353 R354
8	Playback Frequency Measurement (normal)	0 ±2 dB	ATT-255	-	-	-		OUT	OUT				
9	Playback Frequency Measurement (CR ₂)	-4 ±2 dB	ATT-255	-	-	-							
10	Noise Output Level (normal)	Less than 2.5mV	Tape Blank	-	-	-							

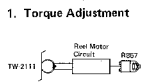

Figure 25

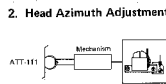

Figure 26

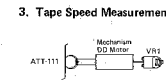

Figure 27

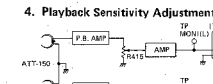



Figure 28

5. ADJUSTMENT INSTRUCTIONS

No	Item	Nominal Specs	Test Tape	Volume Control				Switch Position				Adjustment Position	Test Points	Input Frequency	ATT	Remarks
				REC/BAL	PB	CAL	MONITOR	NR	EXT-DECK	COPY	MPX					
1	Torque Adjustment	50 ±5g-cm	Torque Tape	-	MAX	-	TAPE	OUT	OUT	OUT	OUT	R857	Torque Tape	-		
2	Head Azimuth Adjustment	Maximum	ATT-111	-	-	-						Head Azimuth Adjustment Screw	MONI or LINE OUT	-		After adjustment, apply a lock paint on the screw. 
3	Tape Speed Measurement	3000 ±30 Hz	ATT-111	-	-	-						(Semi-fixed resistor on the Mecha. P.C. Board)	MONI or LINE OUT	-		
4	Playback Sensitivity Adjustment	580 ±10mV	ATT-150	-	-	-						R415 R416	MONI (L) MONI (R)	-		
5	DOLBY DECODE Adjustment															
①	Input Level Adjustment	580 ±10mV	-	-	Adjust.	-		OUT		IN		CAL Volume	MONI (L) MONI (R)	400 Hz -10 dB		
②	DECODE Level Adjustment	580 ±10mV	-	-	Adjust. Position	-				DOLBY		R485 R486	DOLBY (L) DOLBY (R)	400 Hz -10 dB	① Input terminal → EXT-DECK /PLAY	
6	adres DECODE Adjustment														② Don't touch after completion of adjustment.	
①	Input Level Adjustment	300 ±10mV	-	-	-	-						(CAL Volume)	MONI (L) MONI (R)	1 kHz -16.3 dB	③ Deck STOP mode	
②	DECODE Level Adjustment	300 ±10mV	-	-	-	-						R453 R454	adres (L) adres (R)	1 kHz -16.3 dB		
③	DECODE Distortion Adjustment	Less than 0.12%	-	-	-	-						R457 R458	adres (L) adres (R)	1 kHz -16.3 dB		
④	DECODE Limiter Adjustment	+2 ±0.2 dB	-	-	-	-						R469 R470	adres (L) adres (R)	1 kHz -10 kHz -16.3 dB	Variation of 10 kHz referred to 1 kHz	
7	Meter Adjustment	AD mark	-	-	-	-						R353 R354	Meter	1 kHz -16.3 dB	(1 dB decreased) White part all turn on → start to light up. Red part all turned off.	
8	Playback Frequency Measurement (normal)	0 ±2 dB	ATT-255	-	-	-				OUT	OUT		MONI or LINE OUT	-		10 kHz level difference referred to 315 Hz level
9	Playback Frequency Measurement (C.O.C.)	-4 ±2 dB	ATT-255	-	-	-							MONI or LINE OUT	-		Variation from 10 kHz normal
10	Noise Output Level (normal)	Less than 2.5mV	Tape Blank	-	-	-							MONI or LINE OUT	-		

1. Torque Adjustment

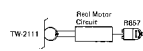

Figure 25

2. Head Azimuth Adjustment

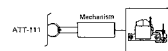

Figure 26

3. Tape Speed Measurement

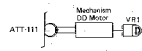

Figure 27

4. Playback Sensitivity Adjustment



Figure 28

5. DOLBY DECODE Adjustment

① Input Level Adjustment

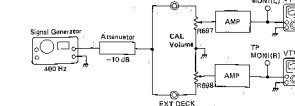

Figure 29

② DECODE Level Adjustment

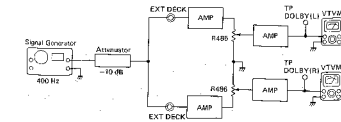

Figure 30

6. adres DECODE Adjustment

① Input Level Adjustment

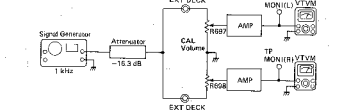

Figure 31

② DECODE Level Adjustment

③ DECODE Distortion Adjustment

④ DECODE Limiter Adjustment

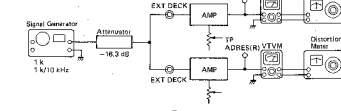

Figure 32

7. Meter Adjustment

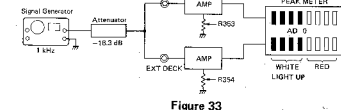

Figure 33

Measurement

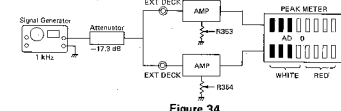

Figure 34

8. Playback Frequency Measurement (normal)

9. Playback Frequency Measurement (C.O.C.)

10. Noise Output Level (normal)

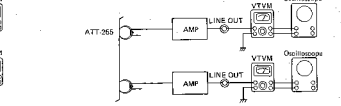

Figure 35

No	Item	Nominal Specs	Test Tap	Volume Control			Switch Position					Adjustment Position	Test Points	Input Frequency ATT	Remarks
				REC/BAL	PB	CAL	MONITOR	NR	EXT-DECK	COPY	MPX				
11	OSC Frequency Adjustment	105 kHz ±50 Hz	AC-711	-	MAX	-	TAPE	-	OUT	OUT	OUT	Z607	(T.P.) BIAS	-	
12	Bias Sensitivity Adjustment	MAX	AC-711	-	-	-	-	-	-	-	-	Z608	(T.P.) BIAS	-	
13	Bias Trap Adjustment	MIN ($<15\text{mV}$)	AC-711	-	-	-	-	-	-	-	-	Z601 Z602	TRAP (L) TRAP (R)	-	
14	MOS Adjustment	DC 1.8 ±0.1V	-	-	-	-	-	-	-	-	-	R362	REF-MOS	-	
15	Built-in OSC level Adjustment	300 ±10mV	-	Adjustment /Center	-	-	-	-	-	OSC	-	REC-VR → LCH R130 → RCH	DOLBY OUT (LCH) DOLBY OUT (RCH)	-	
16	adres ENCODE Adjustment	-	-	-	-	-	-	-	-	-	-	-	-	-	
①	Input Level Adjustment	300 ±10mV	-	Adjustment	-	-	-	-	-	OUT	-	REC-1 → VR BAL → VR	DOLBY OUT (LCH) DOLBY OUT (RCH)	1 kHz -20 dB	Don't vary after completion of REC/BAL VR adjustment
②	ENCODE Level Adjustment	300 ±10mV	-	Adjustment Position	-	-	-	-	-	adres	-	R549 R550	ENCODE (L) ENCODE (R)	1 kHz -20 dB	(Input Terminal → LINE-IN)
③	ENCODE Distortion Adjustment	Less than 0.12%	-	-	-	-	-	-	-	-	-	R553 R554	ENCODE (L) ENCODE (R)	1 kHz -20 dB	
④	ENCODE Limiter Adjustment	-2 ±0.2 dB	-	-	-	-	-	-	-	-	-	R563 R564	ENCODE (L) ENCODE (R)	1 kHz -10 kHz -20 dB	
⑤	ENCODE DUPLI Check	+2 ±1.5 dB -0.5 dB	-	-	-	-	-	-	-	DUPLI	-	-	-	-	
17	REC/PB Frequency Adjustment (CrO ₂)	0 ~ +1.0 dB	AC-512	-	-	-	-	-	-	OUT	-	R681 R682	{ MONI or LINE OUT	333 Hz -10 kHz -40 dB	
18	REC/PB Frequency Adjustment (normal)	0 ~ +1.0 dB	AC-212	-	-	-	-	-	-	-	-	R773	{ MONI or LINE OUT	333 Hz -10 kHz -40 dB	L/RCH difference -2 dB
19	REC/PB Frequency Adjustment (metal)	0 ~ +1.0 dB	AC-711	-	-	-	-	-	-	-	-	R771	{ MONI or LINE OUT	333 Hz -14 kHz -40 dB	L/RCH difference -5 dB
20	REC/PB Sensitivity Adjustment (CrO ₂)	SOURCE Level	AC-512	-	-	-	-	-	-	-	-	R603 R604	{ MONI or LINE OUT	333 Hz -17 dB	Auto tuning in Fix position

11. OSC Frequency Adjustment

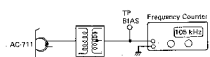

Figure 36

12. Bias Sensitivity Adjustment

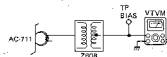

Figure 37

13. Bias Trap Adjustment

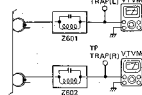

Figure 38

14. MOS Adjustment

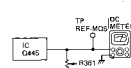

Figure 39

15. Built-in OSC Level Adjustment

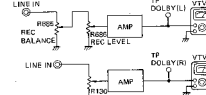

Figure 40

16. adres ENCODE Adjustment

① Input Level Adjustment

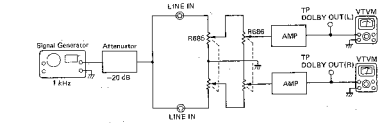

Figure 41

② ENCODE Level Adjustment
③ ENCODE Limiter Adjustment

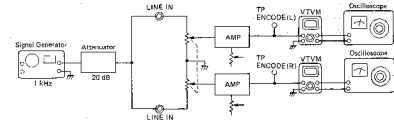

Figure 42

④ ENCODE Limiter Adjustment
⑤ ENCODE DUPLI Check

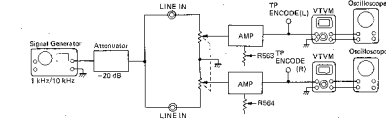

Figure 43

17. REC/PB Frequency Adjustment (CrO₂)
18. REC/PB Frequency Adjustment (normal)
19. REC/PB Frequency Adjustment (metal)
20. REC/PB Sensitivity Adjustment (CrO₂)

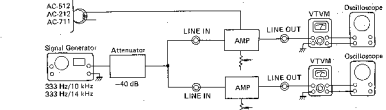



Figure 44

6. VOLTAGE CHART

20. Auto-tuning Alignment Method

1. Connect test point **A/D** to the ground.
2. Connect both ends of connector terminal **J705**, using a short jumper jig. 
3. Use the test tape **AC-512**.
4. Connect AC millivoltmeter and oscilloscope as shown below.
5. Use oscilloscope.

Step	Item	Reference Value	Tape Used	Switch		Alignment Point	Test Point	Note
				AUTO/FIX	START			
1	AF Oscillator 1 kHz Alignment	400mV	AC512	AUTO (AUTO LED turns on)	ON	R730	TP OSC	Repeat to push start switch as OSC stops after 10 sec. elapsed.
2	Auto-tuning 1 kHz Level Alignment	HIGH → LOW LOW Level	AC-512	AUTO (AUTO LED turns on)	ON	R323	TP A/D-IN When "H" changed to "L"	
3	AF Oscillator 10 kHz Alignment	40mV	AC-512	AUTO (AUTO LED turns on)	ON	R732	Ground TP 10K.AT TP OSC	
4	Auto-tuning 10 kHz Level Alignment	LOW Level Longer "L" period	AC-512	AUTO (AUTO LED turns on)	ON	R327	TP A/D-IN OV  NG	

* After completion of the alignment, remove the short jumper jig from J705 and short-circuits C709.

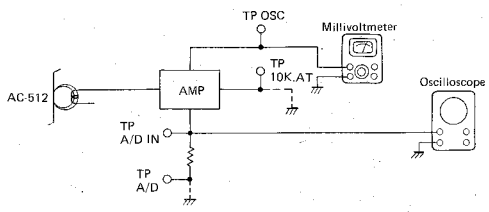

Figure 45

NR P.C. Board

Q401, 402 Others
 1 1.5V
 2 0.0V
 3 0.0V
 4 7.8V
 5 4V
 6 3.5V

Q403 Others
 1 0V
 2 4V
 3 5.6V
 4 4V
 5 0V
 6 3.5V

Q404 Others
 1 AGES -0.02V
 2 AGES -0.000V
 3 0V
 4 7.6V
 5 0V
 6 0.000V

Q405, 406 Others
 1 0V
 2 0V
 3 0V
 4 7.8V
 5 0V

Q407, 408 Others
 1 0V
 2 0V
 3 0V
 4 0V
 5 0V
 6 0V

Q409, 410 Others
 1 0V
 2 0V
 3 0V
 4 0V
 5 0V
 6 0V

POWER P.C. Board

Q901 Others
 1 -3.0V
 2 0V
 3 8.3V

Q902 Others
 1 28V
 2 25V
 3 24.6V

JACK P.C. Board

Q101 Others
 1 0.12V
 2 0V
 3 -18V
 4 0V
 5 0V
 6 0.14V
 7 0V

Q102 Others
 1 0.910V
 2 0V
 3 -12V
 4 0V
 5 0.14V
 6 0.14V
 7 0V

Q103, 104 Others
 1 0V
 2 0V
 3 0V
 4 0V
 5 0V
 6 0V

Q105, 106 Others
 1 0V
 2 0V
 3 0V
 4 0V
 5 0V
 6 0V

Q107, 108 Others
 1 0V
 2 0V
 3 0V
 4 0V
 5 0V
 6 0V

METER P.C. Board

Q120 Others
 1 0V
 2 0V
 3 0V
 4 0V
 5 0V
 6 0V

Q121 Others
 1 3.9V
 2 0V
 3 2.4V
 4 0V
 5 2.3V
 6 1.8V
 7 0V
 8 0V
 9 0V

Q122 ~ 125 Others
 1 3.5V
 2 0V
 3 4.6V
 4 0V
 5 0V
 6 0V
 7 0V
 8 0V
 9 0V

COUNTER P.C. Board

Q131 Others
 1 5V
 2 0V
 3 0V
 4 0V
 5 0V
 6 0V
 7 0V
 8 0V
 9 0V
 10 0V
 11 0V
 12 0V
 13 0V
 14 0V
 15 0V
 16 0V
 17 0V
 18 0V
 19 0V
 20 0V
 21 0V
 22 0V
 23 0V
 24 0V
 25 0V
 26 0V
 27 0V
 28 0V
 29 0V
 30 0V

Q132 Others
 1 0.85V
 2 1.4V
 3 4.6V

Q133 Others
 1 0V
 2 0V
 3 0V
 4 0V
 5 0V
 6 0V

Q134, 135 Others
 1 4.6V
 2 0V
 3 0V
 4 0V
 5 0V
 6 0V

Q136 Others
 1 0V
 2 0V
 3 0V
 4 0V

Q427, 428 Others
 1 0V
 2 0V
 3 0V
 4 0V
 5 0V
 6 0V

Q429 ~ 432 Others
 1 0V
 2 0V
 3 0V
 4 0V
 5 0V
 6 0V

Q450 Others
 1 0V
 2 0V
 3 0V
 4 0V
 5 0V
 6 0V

Q452 Others
 1 0V
 2 0V
 3 0V
 4 0V
 5 0V
 6 0V

Q454 Others
 1 7.6V
 2 0V
 3 0V
 4 0V
 5 0V
 6 0V

Q455 Others
 1 2.5V
 2 0V
 3 0V
 4 0V
 5 0V
 6 0V

Q445 Others
 1 AGES 0.66V
 2 RECAL 0.000V
 3 RECAL 0.000V
 4 RECAL 0.000V
 5 RECAL 0.000V
 6 RECAL 0.000V
 7 RECAL 0.000V
 8 RECAL 0.000V
 9 RECAL 0.000V
 10 RECAL 0.000V
 11 RECAL 0.000V
 12 RECAL 0.000V
 13 RECAL 0.000V
 14 RECAL 0.000V
 15 RECAL 0.000V
 16 RECAL 0.000V
 17 RECAL 0.000V
 18 RECAL 0.000V
 19 RECAL 0.000V
 20 RECAL 0.000V

Q446 Others
 1 7.6V
 2 0V
 3 0V
 4 0V
 5 0V
 6 0V

Q449 Others
 1 AGES LEVEL
 2 REC.PLAY
 3 3.2V
 4 0V
 5 0V
 6 0V
 7 0V
 8 0V
 9 0V
 10 0V
 11 0V
 12 0V
 13 0V
 14 0V
 15 0V
 16 0V
 17 0V
 18 0V
 19 0V
 20 0V
 21 0V
 22 0V
 23 0V
 24 0V
 25 0V
 26 0V
 27 0V
 28 0V
 29 0V
 30 0V

Q449 Others
 1 7.6V
 2 0V
 3 0V
 4 0V
 5 0V
 6 0V

Q456 Others
 1 AGES LEVEL
 2 REC.PLAY
 3 3.2V
 4 0V
 5 0V
 6 0V
 7 0V
 8 0V
 9 0V
 10 0V
 11 0V
 12 0V
 13 0V
 14 0V
 15 0V
 16 0V
 17 0V
 18 0V
 19 0V
 20 0V
 21 0V
 22 0V
 23 0V
 24 0V
 25 0V
 26 0V
 27 0V
 28 0V
 29 0V
 30 0V

Q459 Others
 1 0V
 2 0V
 3 0V
 4 0V
 5 0V
 6 0V

MAIN P.C. Board

Q605, 604 Others

Q605-610, Q615, 616 Others

Q613, 614 Others

Q613, 614 Others

Q619, 620 Others

Q621, 622 Others

Q623, 624 Others

Q625, 626 Others

Q617, 618 Others

Q627 Others

Q628 Others

Q630 Others

Q631 Others

Q633 Others

Q634 Others

Q635 Others

Q636 Others

Q638 Others

Q637 Others

Q638 Others

Q714 Others

Q701 Others

Q702 Others

Q705 Others

Q706 Others

Q707 Others

Q708 Others

Q709 Others

Q710 Others

Q711 Others

Q712 Others

Q713 Others

Q714 Others

Q715 Others

Q716 Others

Q717 Others

Q718 Others

Q719 Others

Q720 Others

Q721 Others

Q722 Others

Q723 Others

Q724 Others

Q703 Others

Q704 Others

Q705 Others

Q706 Others

Q707 Others

Q708 Others

Q709 Others

Q710 Others

Q711 Others

Q712 Others

Q713 Others

Q714 Others

Q715 Others

Q716 Others

Q717 Others

Q718 Others

Q719 Others

Q720 Others

Q721 Others

Q722 Others

Q723 Others

Q724 Others

Q725 Others

Q726 Others

Q727 Others

Q728 Others

Q729 Others

Q730 Others

Q731 Others

Q732 Others

Q722 Others

Q723 Others

Q724 Others

Q725 Others

Q726 Others

Q727 Others

Q728 Others

Q729 Others

Q730 Others

Q731 Others

Q732 Others

Q733 Others

Q734 Others

Q735 Others

Q736 Others

Q737 Others

Q738 Others

Q739 Others

Q740 Others

Q741 Others

Q742 Others

Q743 Others

Q744 Others

Q745 Others

Q746 Others

Q747 Others

Q748 Others

Q749 Others

Q750 Others

Q751 Others

Q734 Others

Q735 Others

Q736 Others

Q737 Others

Q738 Others

Q739 Others

Q740 Others

Q741 Others

Q742 Others

Q743 Others

Q744 Others

Q745 Others

Q746 Others

Q747 Others

Q748 Others

Q749 Others

Q750 Others

Q751 Others

Q752 Others

Q753 Others

Q754 Others

Q755 Others

Q756 Others

Q757 Others

Q758 Others

Q759 Others

Q760 Others

Q761 Others

Q762 Others

Q763 Others

Q748 Others

Q749 Others

Q750 Others

Q751 Others

Q752 Others

Q753 Others

Q754 Others

Q755 Others

Q756 Others

Q757 Others

Q758 Others

Q759 Others

Q760 Others

Q761 Others

Q762 Others

Q763 Others

Q764 Others

Q765 Others

Q766 Others

Q767 Others

Q768 Others

Q769 Others

Q770 Others

Q771 Others

Q772 Others

Q773 Others

Q774 Others

Q775 Others

Q776 Others

Q777 Others

Q757 Others

Q758 Others

Q759 Others

Q760 Others

Q761 Others

Q762 Others

Q763 Others

Q764 Others

Q765 Others

Q766 Others

Q767 Others

Q768 Others

Q769 Others

Q770 Others

Q771 Others

Q772 Others

Q773 Others

Q774 Others

Q775 Others

Q776 Others

Q777 Others

Q778 Others

Q779 Others

Q780 Others

Q781 Others

Q782 Others

Q783 Others

Q784 Others

Q785 Others

Q786 Others

Q765 Others

Q766 Others

Q767 Others

Q768 Others

Q769 Others

Q770 Others

Q771 Others

Q772 Others

Q773 Others

Q774 Others

Q775 Others

Q776 Others

Q777 Others

Q778 Others

Q779 Others

Q780 Others

Q781 Others

Q782 Others

Q783 Others

Q784 Others

Q785 Others

Q786 Others

Q787 Others

Q788 Others

Q789 Others

Q790 Others

Q791 Others

Q792 Others

Q793 Others

Q794 Others

ELECTRICAL PARTS LOCATIONS (MECHANISM BLOCK)

7. ELECTRICAL PARTS LOCATIONS

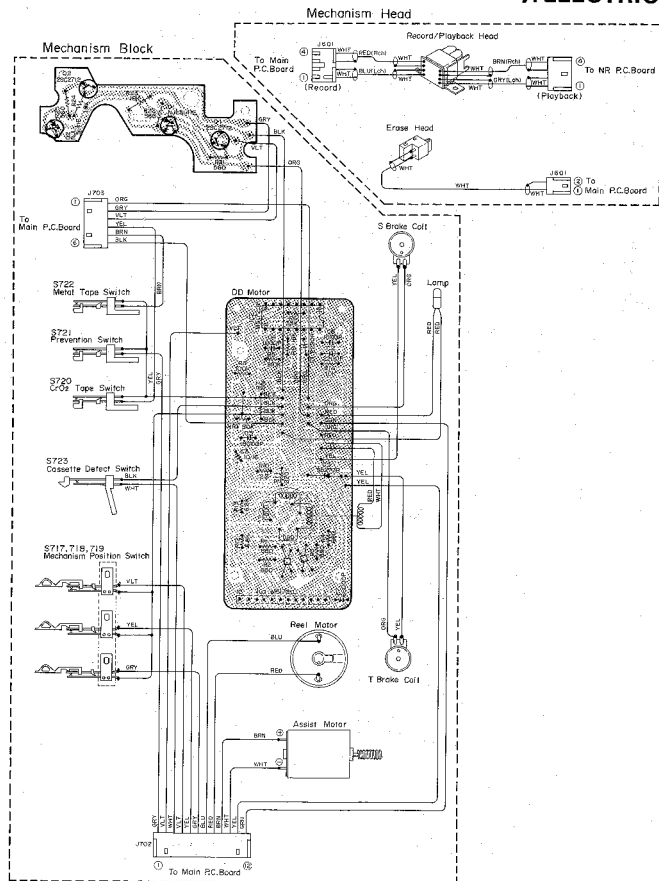

SCHEMATIC DIAGRAM (MECHANISM BLOCK)

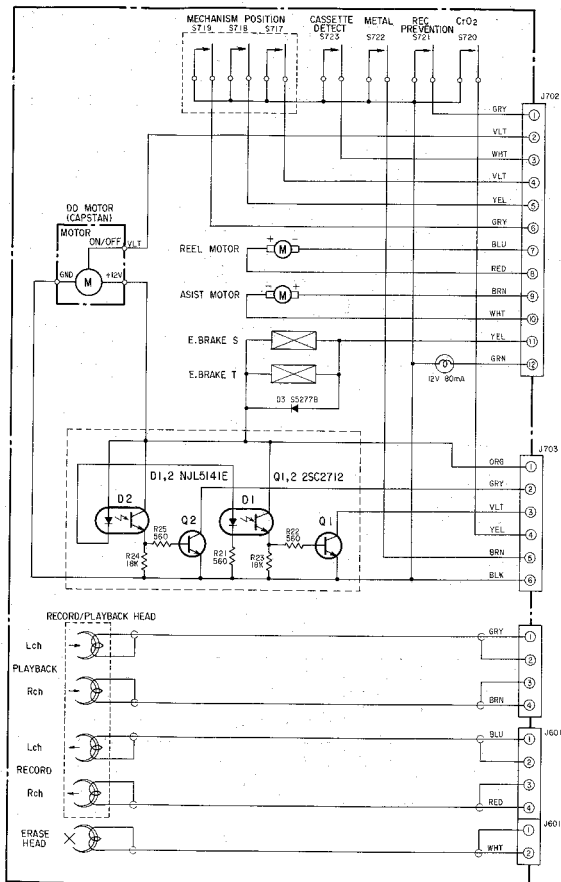

Figure 46

ELECTRICAL PARTS LOCATIONS (OTHER P.C. BOARDS)

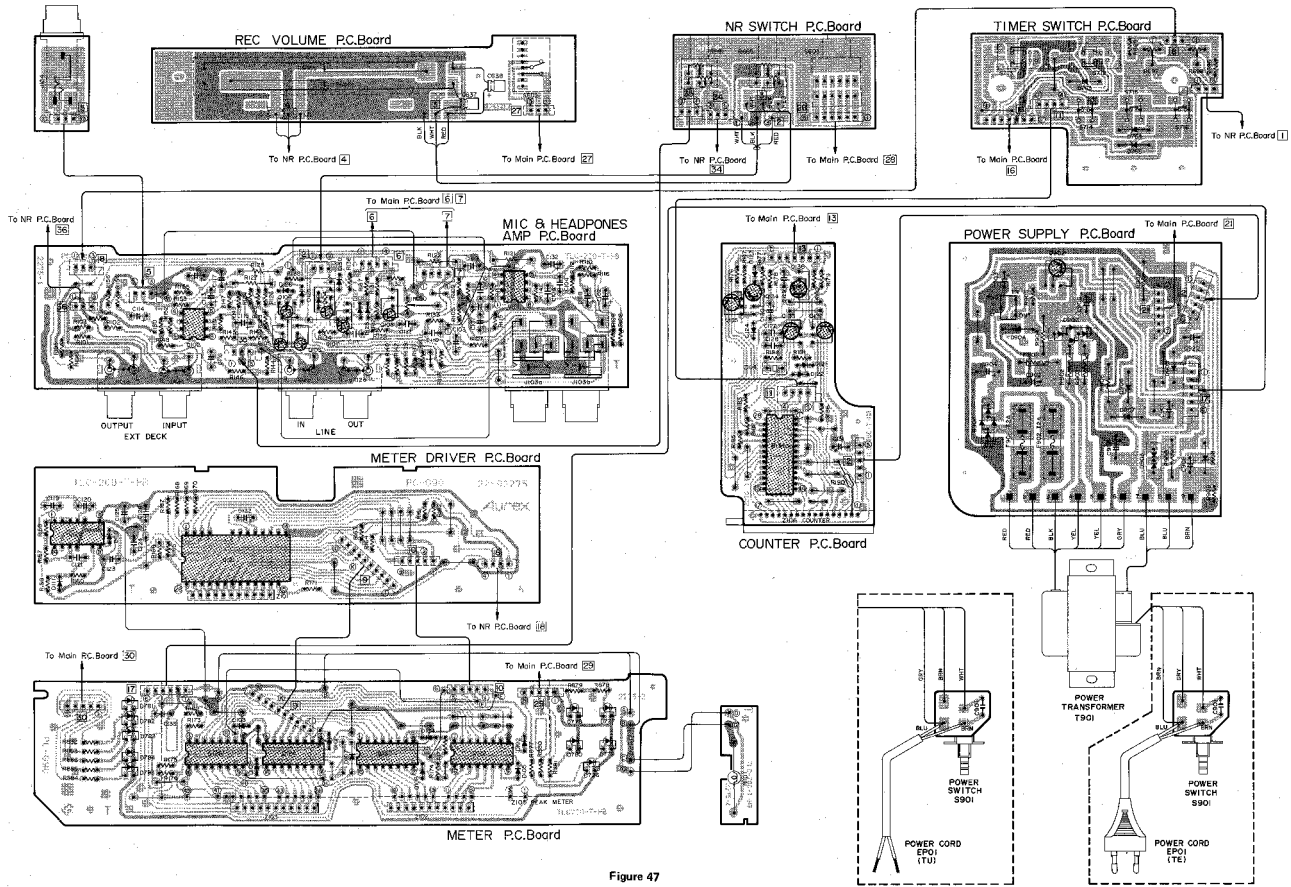

Figure 47

ELECTRICAL PARTS LOCATIONS (NR P.C. BOARD)

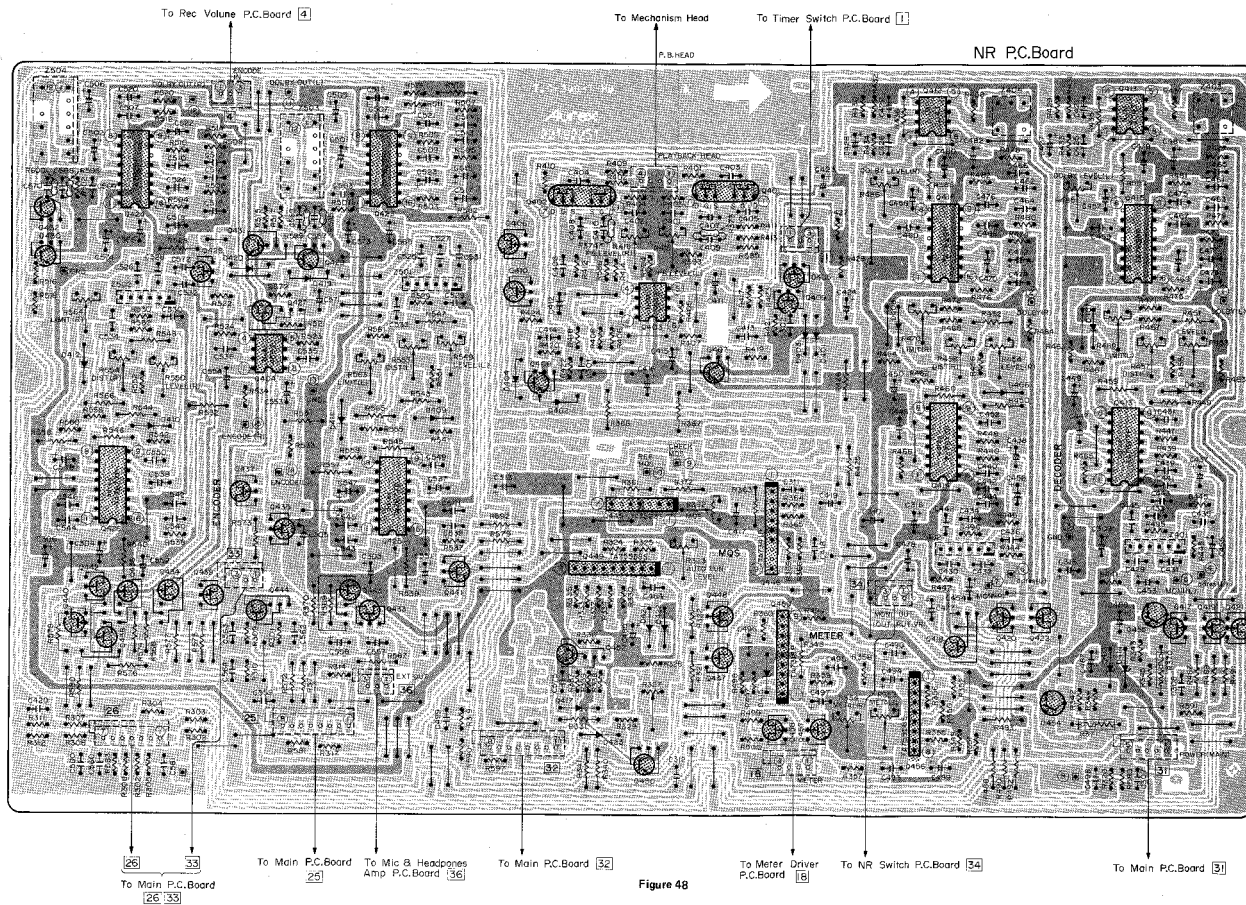

Figure 48

ELECTRICAL PARTS LOCATIONS (NR P.C. BOARD)

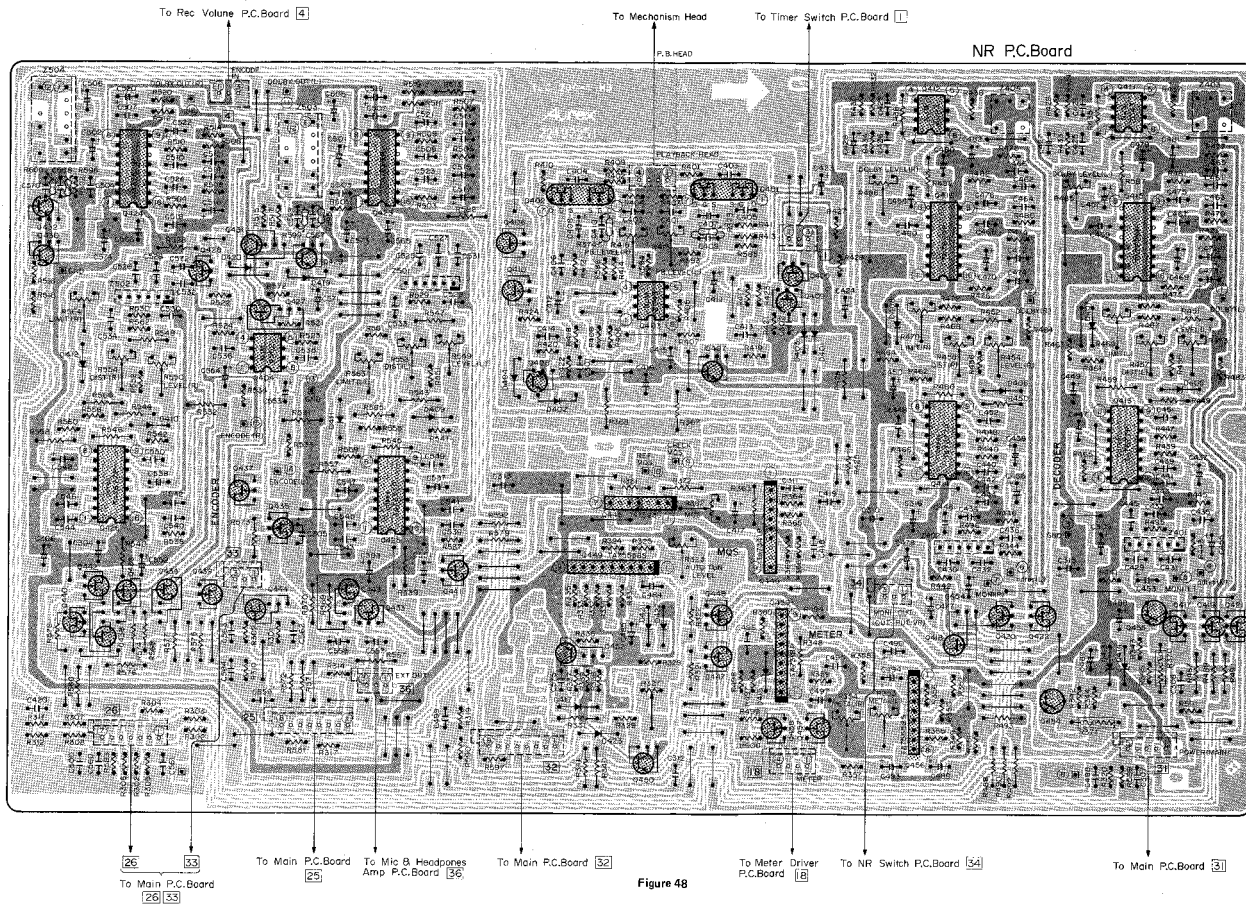
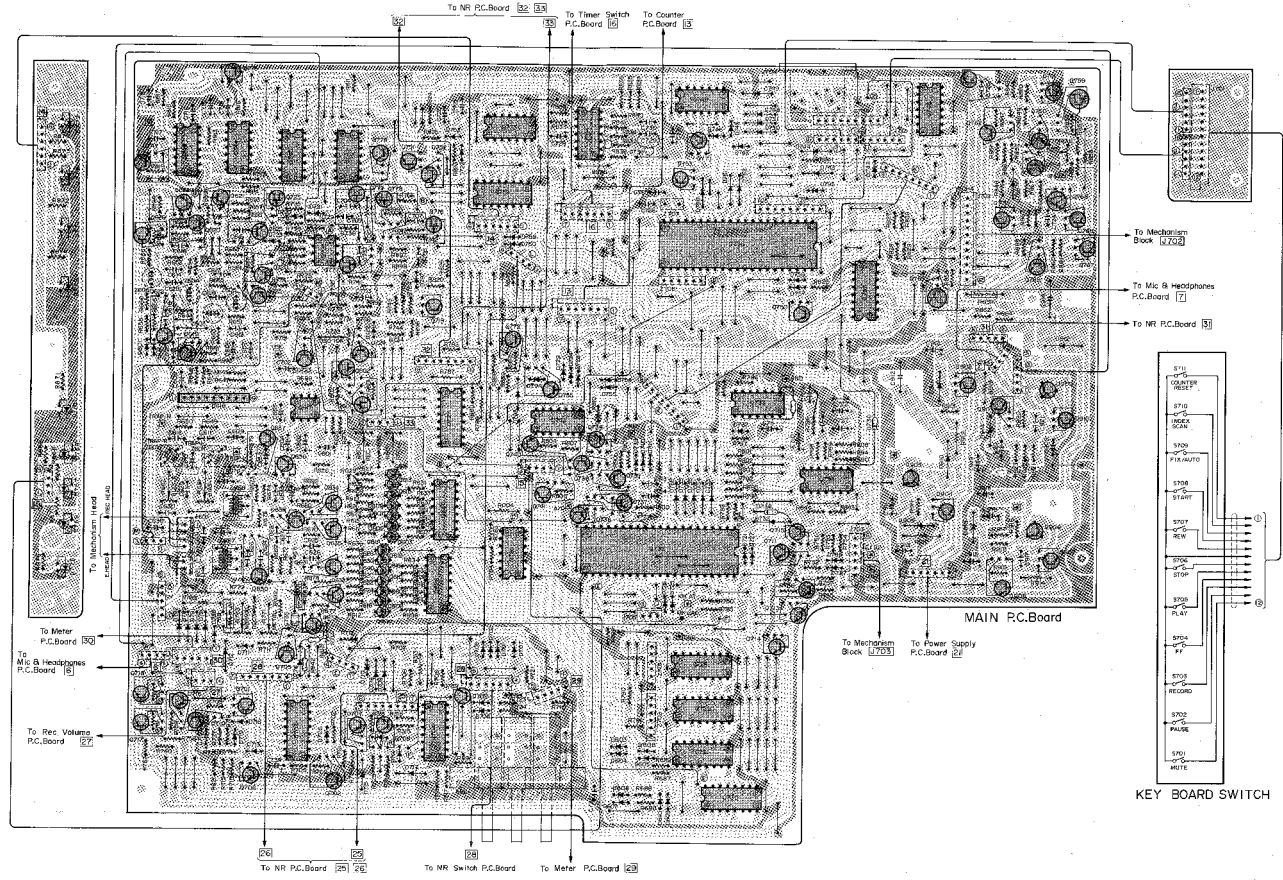
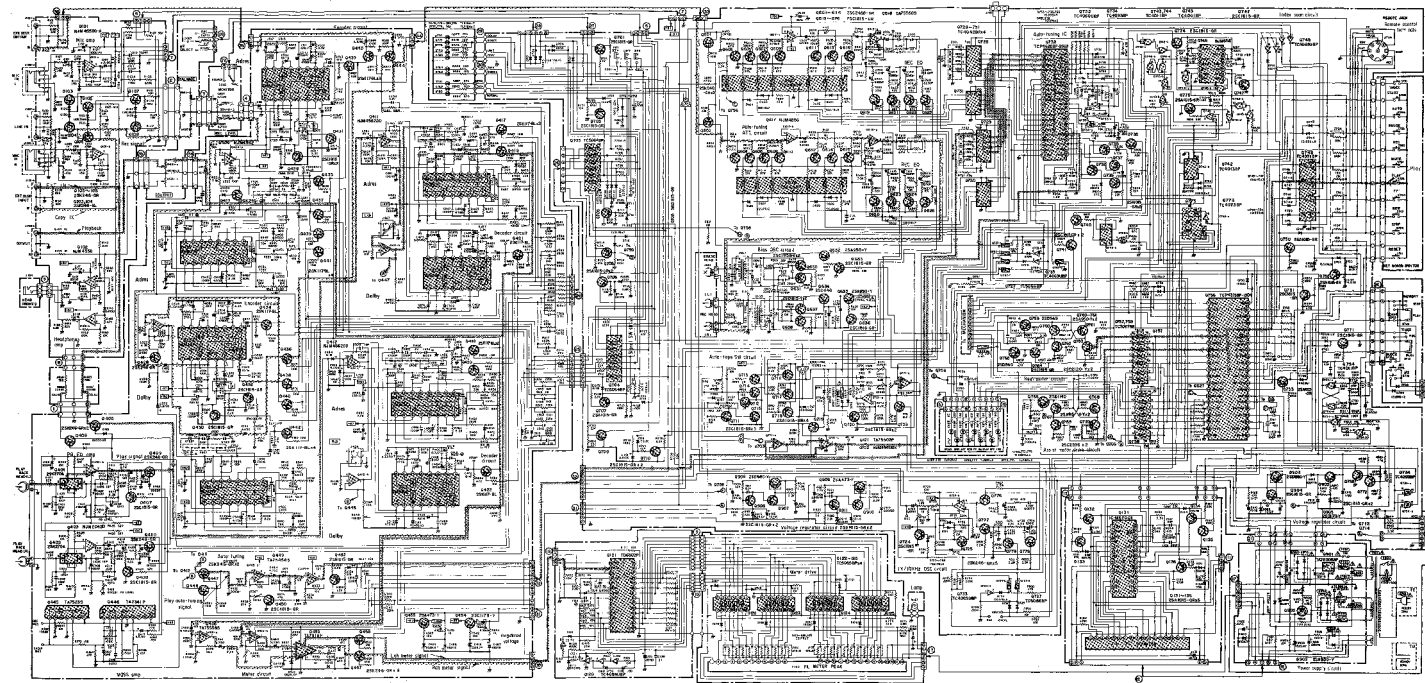

Figure 48

ELECTRICAL PARTS LOCATIONS (MAIN P.C. BOARD)



8. SCHEMATIC DIAGRAM



Name of switch	Current position			
S601-a	: External deck adres unit switch	OFF	S711	: Counter reset switch
S601-b	: Copy switch	OFF	S712	: Memory switch
S601-c	: Multiplex filter switch	OFF	S713	: Timer switch
S602	: Monitor switch	Tape	S714	: Block reset switch
S603	: Noise reduction switch	adres	S715	: Memory 1 switch
S701	: Mute switch	OFF	S716	: Memory 2 switch
S702	: Pause switch	OFF	S717	: Tape position detection switch
S703	: REC switch	?		
S704	: FF switch	OFF	S719	
S705	: Play switch	OFF	S720	: Chromium tape switch
S706	: Stop switch	OFF	S721	: Erase protection switch
S707	: FREN switch	OFF	S722	: Metal tape switch
S708	: Start switch	OFF	S723	: Cassette tape detection switch
S709	: Fix auto switch	OFF	S901	: Power switch
S710	: Index scan switch	OFF		

CAUTION:
The \square mark, the symbol No. circled with rectangle in the schematic diagram and the shaded area in the parts list designate components which have special characteristics important for safety and should be replaced only with types identical to those in the original circuit or specified in the parts list.

Figure 52

9-1. EXPLODED VIEW MECHANISM

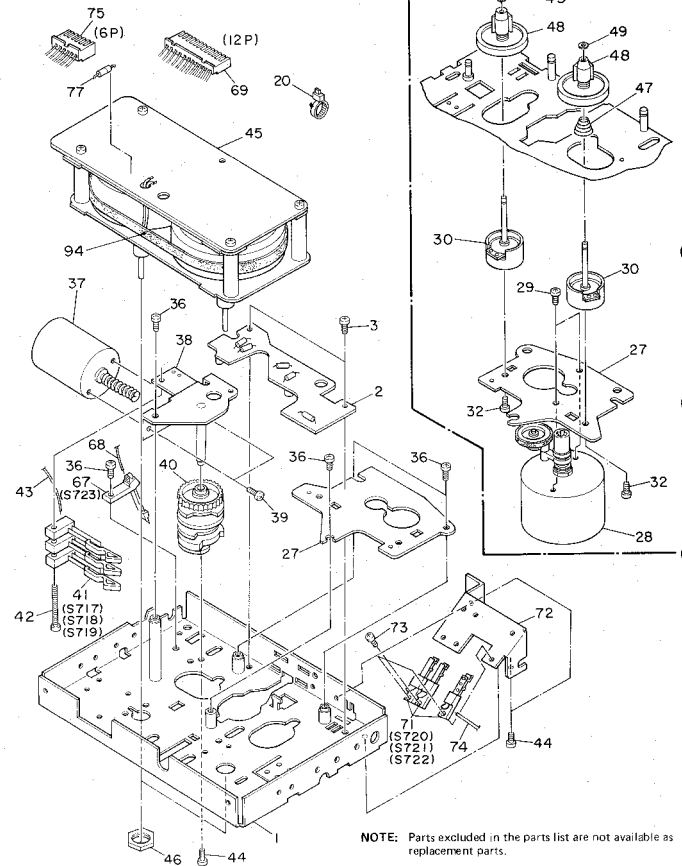
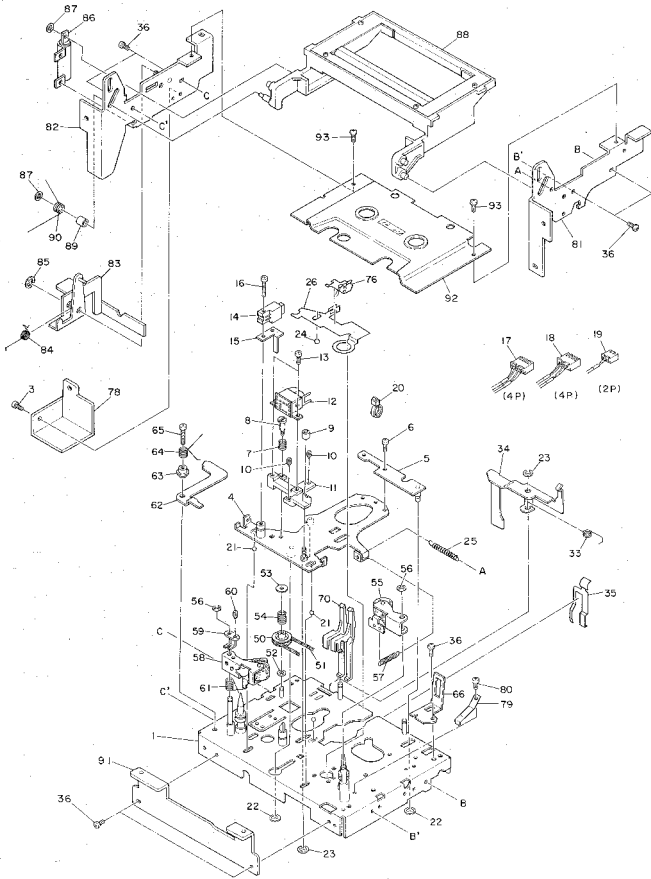

Figure 53

NOTE: Parts excluded in the parts list are not available as replacement parts.

9-2.MECHANISM PARTS LIST

Symbol No.	Part No.	Description	Symbol No.	Part No.	Description
1	25791600	Mechanism Chassis Ass'y	58	25717574	Pressure Roller Ass'y, S
3	22707989	Screw, 2.5φ x 4mm, FT	59	25748964	Adjust Plate
4	25791601	Head Base Ass'y	60	22707994	Screw, 2φ x 3mm
5	25791602	Plate Ass'y, Connection	61	25778124	Spring
6	22707990	Screw, 2.5φ x 3.5mm, FT	63	25753361	Collar
7	25777244	Spring	64	25773125	Spring
8	22707991	Screw, Pivot	65	22707995	Screw, 2.5φ x 10mm
9	22702201	Nut, Adjustment	67	22196271	Leaf Switch
10	22701440	Screw, 2φ x 4mm	70	25748967	Lever, Record
11	25791603	Head Block	71	22196272	Leaf Switch
12	22217410	Head, Record/Playback, HRPT-410	73	22707265	Screw, 2φ x 4mm
13	22701270	Screw, 2φ x 4mm	76	25748965	Lamp Holder Ass'y
14	22218265	Head, Erase	77	A7978380	Diode, Sb2778
16	22707508	Screw, 2φ x 12mm	79	25779342	Spring, Cassette
21	25757116	Steel Ball, 2φ	80	22707996	Screw
22	22703279	E Ring, 3φ	82	25791607	Side Plate Ass'y, Left
23	22703119	E Ring, 2.5φ	83	25748966	Release Lever Ass'y
24	25757120	Steel Ball, 3φ	84	25778127	Spring
25	25776600	Spring	85	22703279	E Ring, 3φ
26	25791604	Head Holder Plate	86	25857181	Damper Unit
28	25791605	Reel Motor Ass'y, with Idler	87	20798037	CS Ring, 1.9φ
29	22701389	Screw, 2.6φ x 3mm	88	25881845	Cassette Holder Ass'y
30	22147257	Electromagnet Brake Coil	89	25753362	Collar
32	22707992	Screw, 2.3φ x 4mm	90	25778126	Spring
33	25778123	Spring	92	25791610	Mechanism Cover Ass'y
34	25748963	Detector Lever	93	22707997	Screw, 2.5φ x 3.5mm, FT
35	25779343	Spring, Cassette Tape	94	25755583	Belt, DD Motor
36	22707350	Screw, 2.6φ x 5mm			
37	25791608	PAD Motor Ass'y			
38	25791606	Cam Gear Mount			
39	22701467	Screw, 2φ x 3mm			
40	25756371	Cam Gear			
41	22196270	Leaf Switch			
42	22707993	Screw, 2.5φ x 20mm			
44	22701270	Screw, 2φ x 4mm			
45	25791609	DD Motor Ass'y, with Flywheel			
46	22702107	Nut, 9φ			
47	25777245	Spring			
48	25712438	Reel Ass'y			
49	25766050	Washer, 1.6φ			
50	25713574	Pulley			
51	25755582	Belt, Back Tension			
52	25766125	Washer			
53	25766123	Washer			
54	25777246	Spring			
55	25717573	Pressure Roller Ass'y			
56	22703118	E Ring, 2φ			
57	25776602	Spring			

10-1. EXPLODED VIEW CABINET

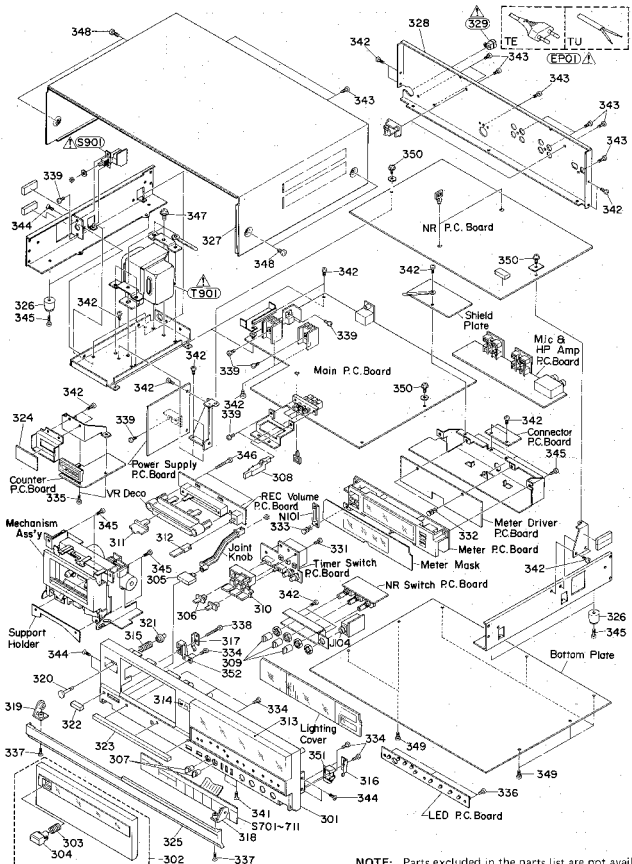

NOTE: Parts excluded in the parts list are not available as replacement parts.

Figure 54

10-2. CABINET PARTS LIST

CAUTION:

The Δ mark, the symbol No. circled with rectangle in the schematic diagram and the shaded area in the parts list designate components which have special characteristics important for safety and should be replaced only with types identical to those in the original circuit or specified in the parts list.

Symbol No.	Part No.	Description	Symbol No.	Part No.	Description
301	25829518	Front Panel Ass'y	345	22707844	Screw, 3 ϕ x 10mm, BID Tapping
302	25881642	Cassette Cover Ass'y	346	22707932	Screw, 3 ϕ x 25mm, BID
303	25777192	Spring, Eject	347	22707196	Screw, 4 ϕ x 8mm, FLETPAN
304	25837919	Knob, Power	348	22707519	Screw, 4 ϕ x 10mm, DTBID
305	25837938	Knob, Timer/Memory	349	22707942	Screw, 3 ϕ x 6mm, DTBID Tapping
306	25837970	Knob, Calibration,	350	22707798	Screw, 3 ϕ x 10mm, DTPAN
307	25837937	Knob, EXT Deck/Copy/MPX	351	25833533	Sealing Guide, Left
308	25837934	Knob, NR/Balance/Output	352	25833534	Sealing Guide, Right
309	25837936	Knob, Block Repeat/			
310	25837933	Knob, Record Level			
311	25837931	Knob, Monitor/Source/Tape			
312	25837932	Meter Cover			
313	25832714	Counter Cover			
314	25832715	Spring			
315	25777195	Spring, Left			
316	25779314	Spring, Right			
317	25779315	Shaft, Left			
318	25810144	Shaft, Right			
319	25810145	Eject Pin, A			
320	25810146	Eject Pin, B			
321	25810147	Decoration Panel, A			
322	25814363	Decoration Panel, B			
323	25814364	Filter, Counter			
324	25832761	Sealing Ass'y			
325	25881881	Foot			
326	22874041	Top Cover			
327	25864210	Jack Plate (TE)			
328	25864245	Jack Plate (TU)			
329	25845329	Core Bush			
331	22701325	Screw, 3 ϕ x 8mm, BID			
332	22705020	Plastic Rivet, 3 ϕ x 4.5mm			
333	22705026	Plastic Rivet, 3 ϕ x 6.5mm			
334	22707037	Screw, 2.6 ϕ x 6mm, BID			
335	22707366	Screw, 2.6 ϕ x 6mm, DTBID			
336	22707323	Screw, 2.6 ϕ x 8mm, BID			
337	22707931	Screw, 2.6 ϕ x 10mm, FLT Tapping			
338	22707918	Screw, 2.6 ϕ x 20mm, BID			
339	22707086	Screw, 3 ϕ x 6mm, BID			
341	22707051	Screw, 3 ϕ x 6mm, FLT			
342	22707842	Screw, 3 ϕ x 8mm, DTBID Tapping			
343	22707911	Screw, 3 ϕ x 8mm, DTBID Tapping			
344	22707909	Screw, 3 ϕ x 8mm, DTFLT Tapping			

11. PARTS LIST

CAUTION:

The Δ mark, the symbol No. circled with rectangle in the schematic diagram and the shaded area in the parts list designate components which have special characteristics important for safety and should be replaced only with types identical to those in the original circuit or specified in the parts list.

Symbol No.	Part No.	Description	Symbol No.	Part No.	Description
IC'S, TRANSISTORS & DIODES					
Q101	22114470	IC, NJM4558D-A	Q601, 602	A6044630	Transistor, 2SK246-GR
Q102	22114901	IC, NJM4556	Q603, 604,	A6332440	Transistor, 2SC2458-GR
Q103, 104	A6044640	Transistor, 2SK246-BL	605, 606,		
Q105, 106,	A6044630	Transistor, 2SK246-GR	607, 608,		
107, 108			609, 610,		
Q120	B0470693	IC, TC4068UBP	611, 612,		
Q121	22117218	IC, TD6302P	613, 614,		
Q122, 123,	B0480652	IC, TC5065BP	615, 616		
124, 125			Q617	22114901	IC, NJM4556
Q131	22117083	IC, M62001	Q618	B0350510	IC, TA75568S
Q132, 133,	A6534060	TTransistor, 2SA1015-GR	Q619, 620,	A6317460	Transistor, 2SC1815NEW-GR
134, 135,			621, 622,		
136			623, 624,		
Q401, 402	A6046030	Transistor, 2SK270A-BL	625, 626,		
Q403	22117147	IC, NJM2043D	627, 628		
Q404, 411,	22114979	IC, NJM4562DD	Q630, 631	A6319300	Transistor, 2SC1959NEW-Y
412			Q632, 635	A6532940	Transistor, 2SA950-Y
Q405, 406,	A6044630	Transistor, 2SK246-GR	Q634	A6857700	Transistor, 2SD1140
409, 410,			Q627, 628	B0480662	IC, TC5066BP
427, 428,			Q701, 702,	A6317460	Transistor, 2SC1815NEW-GR
447, 448,	A6317460	Transistor, 2SC1815NEW-GR	705, 709,		
457, 458			710, 711,		
Q407, 408,			712, 713,		
429, 430,			714, 715,		
431, 432,			720, 723,		
450			724, 740,		
Q413, 414,	B0356770	IC, TA7677P	741, 747,		
425, 426			751, 755,		
Q415, 416,	B0356150	IC, TA7629P	764, 771,		
423, 424			772, 774		
Q417, 418,	A6041880	Transistor, 2SK117-BL	Q703, 704	B0480642	IC, TC50648P
419, 420,			Q706, 707,	A6534060	Transistor, 2SA1015-GR
421, 422,			708, 716,		
433, 434,			717, 718,		
435, 436,			719, 735,		
437, 438,			736, 737,		
439, 440,			738, 739,		
441, 442,			750, 752,		
443, 444			753, 775		
Q445	B0347130	IC, TA7523S	Q721	B0351500	IC, TA75902P
Q446	B0325320	IC, TA7341P	Q722	22114866	IC, NJM4560DX
Q449, 456	B0350510	IC, TA75558S	Q725, 776,	A6044630	Transistor, 2SK246-GR
Q452	A6534060	Transistor, 2SA1015-GR	777, 778,		
Q454	A677164A	Transistor, 2SC1173-Y-X	779		
Q455	A8500740	Transistor, 2SA473-Y	Q727	B0480662	IC, TC5066BP
Q459	B0324880	IC, TA7318P-2			

Symbol No.	Part No.	Description	Symbol No.	Part No.	Description
Q728, 729,	B0470422	IC, TC4042BP	D601, 602,	A7160570	Diode, 1SS176
730, 731			603, 604,		
Q732	22117217	IC, TC4620BP-2303	605, 606,		
Q733, 748	B0470693	IC, TC4068UBP	607, 608,		
Q734	B0470932	IC, TC4093BP	609, 610		
Q742	B0470135	IC, TC4013BP	D701, 702,	A7160570	Diode, 1SS176
Q743, 744,	B0470116	IC, TC40118P	703, 704,		
754			705, 706,		
Q745	B0470016	IC, TC40018P	707, 710,		
Q746	22117144	IC, NJM556D	711, 713,		
Q749	B0470713	IC, TC40718P	714, 716,		
Q756	22117082	IC, TMP4315-1304	718, 719,		
Q757, 758	B0480672	IC, TC50678P	720, 721,		
Q759	A6841900	Transistor, 2SD549	722, 723,		
Q760, 761	A6532940	Transistor, 2SA950-Y	724, 725,		
Q762, 763	A6321240	Transistor, 2SC2120-Y	726, 727,		
Q765, 766	A8857700	Transistor, 2SD1140	728, 729,		
Q767, 768	A6533240	Transistor, 2SA966-Y	731, 737,		
Q769, 770	A6325540	Transistor, 2SC2236-Y	739, 740,		
Q773	B0470732	IC, TC4073BP	741, 742,		
Q901	B0372540	IC, TA78005AP	745, 748,		
Q902	A6532940	Transistor, 2SA950-Y	747, 752,		
Q903, 906	A6848520	Transistor, 2SD980-Y	753, 754,		
Q904, 907,	A6317460	Transistor, 2SC1815NEW-GR	755, 756,		
909			757, 759,		
Q905	A677164A	Transistor, 2SC1173-Y-X	760, 786,		
Q909	A6500740	Transistor, 2SA473-Y	787, 788,		
Q910, 911	A6534060	Transistor, 2SA1015-GR	794, 795,		
			797		
D101, 102,	A7160570	Diode, 1SS176	D708, 709	A7246703	Diode, 1S1555V
103, 104,			712, 715,		
105, 106,			717, 733,		
108, 110,			734, 735,		
111, 121,			736, 743,		
122, 123,			744, 748,		
124, 125,			749, 750,		
126, 127,			751, 764,		
128, 129,			765, 766,		
130			776, 789,		
D107	A7246703	Diode, 1S1555V	790, 791,		
D401, 402,	A7246703	Diode, 1S1555V	792, 793		
403, 404,			D732	A7978390	Diode, S5277B
405, 406,			D758	A7110262	Diode, 05Z9.1-Y
407, 408,			D761, 762,	22115808	Diode, 1K60A
409, 410,			763, 796		
411, 412,			D767, 772	A8611940	Diode, TLO124
417, 419,			D768, 774	A8601150	Diode, TLR124
420, 423			D769, 773,	A8606201	Diode, TLLG124A
D413, 414	A1110208	Diode, 05Z8.2-Y-X/Y	775		
D415	A7110017	Diode, 05Z5.6-Y-Z			
D421, 422	22115808	Diode, 1K60A			

Symbol No.	Part No.	Description
D770, 771 D776, 779, 780, 781, 782, 783, 785	A8608500 A8636570	Diode, TLY124 Diode, TLS164
D777, 778, 784	A8606460	Diode, TLG164
D901, 902	22115737	Diode, KBP01
D903	A7662012	Diode, 1B2C1 (1)
D904	A7110664	Diode, 05Z24-Y
D905	A7110262	Diode, 05Z9.1-Y
D906	A7110411	Diode, 05Z12-Y-X/Y
D907, 910, 912	A7978380	Diode, S5277B
D908, 911, 913, 914 D909	A7110017 22115887	Diode, 05Z5.6-Y-Y/Z Diode, XZ137
ELECTRICAL PARTS		
T901	22224246	Transformer, Power
N101	22113592	Lamp, 12V, 80mA, GRN
F901, 902	22144379	Fuse, T2A, 250V
S601	22196165	Switch, Push, EXT DECK/ COPY/MPX
S602 S603 S701, 702, 703, 704, 705, 706, 707, 708, 709, 710, 711 S712, 713 S714, 715, 716	22196164 22196186 26819525	Switch, Push, Monitor Switch, Rotary, NR Key Board Switch Ass'y, Mute/Pause Record/FF Play/Stop REW/Start FIX Auto/Index Scan Counter Reset
	22195566 22195924	Switch, Slide, Memory/Timer Switch, Key, Block Repeat/ Memory-1/Memory-2

Symbol No.	Part No.	Description
S717, 718, 719	22196270	Switch, Leaf, Mecha Position Detector
S720, 721, 722	22196272	Switch, Leaf, Chrome/REC Prevention/Metal
S723	22196271	Switch, Leaf, Tape Detector
S901	22196160	Switch, Push, Power
J101, 102	22163887	Jack, US4P
J103	22163886	Jack, 6p x 2, Microphone
J104	22163889	Jack, 6p, Headphone
J701	22169012	Socket, Jump, Key Board
J704	22167984	DIN Jack, 8P
Z101, 102, 103	22134150	Composite Part, 47K x 10
Z104	22153244	Ceramic Oscillator, 455 KHz
Z105	22104588	Meter, Peak
Z106	22104587	Counter
Z401, 402	22134147	Composite Part, 120K/33K/ 33K/33K/3.9K
Z403, 404	22212065	Coil, Bias Trap, 105 kHz
Z501, 502	22134147	Composite Part, 120K/33K/ 33K/33K/3.9K
Z503, 504	22212064	Filter, Dolby
Z601, 602	22235218	Coil, Bias Trap, 105 KHz
Z603, 604, 605, 606	22232278	Coil, Choke, 8.2mH
Z607, 608	22235226	Coil, Bias Oscillator
Z701, 702	22134154	Composite Part, 50K x 3/10K x 5
Z703	22153188	Ceramic Oscillator, 400 KHz
Z704	22130709	Composite Part, 15K/33K/ 100K/15K/15K/100K/15K/ 15K
Z705	22130708	Composite Part, 15K x 6
Z706	22134167	Composite Part, 4.7K x 5
Z707	22153244	Ceramic Oscillator, 455 KHz
EP01	22176942	Power Cord (TLE)
EP01	22176943	Power Cord (TRU)
EP02	22165047	Fuse Holder

Symbol No.	Part No.	Description
CAPACITORS		
D = ±0.5pF, G = ±2%, J = ±5%, K = ±10%, M = ±20%, Z = -20 + 80%		
ABBREVIATIONS: EL = Electrolytic, CD = Ceramic Disk, MY = Mylar, PP = Polypropylene, PS = Polystyrene		
C101, 102	22488479	EL, 4.7mfd, 50V
C103, 104	22349471	CD, 470pF, 50V, K
C105, 106	22349471	CD, 470pF, 50V, K
C107, 108	22488479	EL, 4.7mfd, 50V
C109	22485470	EL, 47mfd, 16V
C110, 111	22360484	CD, 0.047mfd, 50V, Z
C113, 114	22485330	EL, 33mfd, 16V
C115, 116	22488478	EL, 0.47mfd, 50V
C117, 118	22485470	EL, 47mfd, 16V
C119, 120	22488109	EL, 1mfd, 50V
C121	22342473	CD, 0.047mfd, 50V, Z
C122	22488478	EL, 0.47mfd, 50V
C123	22480006	EL, 0.33mfd, 50V
C124	22371102	MY, 0.001mfd, 50V, J
C125	22483101	EL, 100mfd, 10V
C126	22372104	MY, 0.1mfd, 50V, K
C127	22362680	CD, 68pF, 50V, K
C128	22349221	CD, 220pF, 50V, K
C129	22349471	CD, 470pF, 50V, K
C130	22488109	EL, 1mfd, 50V
C131	22485100	EL, 10mfd, 16V
C132	22485470	EL, 47mfd, 16V
C133	22488100	EL, 10mfd, 50V
C301, 302	22371102	MY, 1000pF, 50V, J
C303, 304	22483471	EL, 470mfd, 10V
C305, 306	22483471	EL, 470mfd, 10V
C307, 308	22342103	CD, 0.01mfd, 50V, Z
C309, 310	22483471	EL, 470mfd, 10V
C311, 312	22342103	CD, 0.01mfd, 50V, Z
C313	22485330	EL, 33mfd, 16V
C315, 316	22483471	EL, 470mfd, 10V
C401, 402	22321164	PP, 220pF, 50V, J
C403, 404	22362101	CD, 100pF, 50V, K
C405, 406	22362180	CD, 18pF, 50V, K
C407, 408	22483101	EL, 100mfd, 10V
C409, 410	22371153	MY, 0.015mfd, 50V, J
C411, 412	22485330	EL, 33mfd, 16V
C413, 414	22372103	MY, 0.01mfd, 50V, K
C415, 416	22483221	EL, 220mfd, 10V
C417	22485100	EL, 10mfd, 16V
C418	22342223	CD, 0.022mfd, 50V, Z
C419	22488339	EL, 3.3mfd, 50V
C420	22342223	CD, 0.022mfd, 50V, Z

Symbol No.	Part No.	Description
C421, 422	22362101	CD, 100pF, 50V, K
C423, 424	22485100	EL, 10mfd, 16V
C425, 426	22362180	CD, 18pF, 50V, K
C427, 428	22488479	EL, 4.7mfd, 50V
C429, 430	22321307	PP, 4700pF, 100V, G
C431, 432	22321309	PP, 235pF, 100V, G
C433, 434	22321308	PP, 910mfd, 100V, G
C435, 436	22321306	PP, 1500pF, 100V, G
C437, 438	22485100	EL, 10mfd, 16V
C439, 440	22361809	CD, 8pF, 50V, D
C441, 442	22349221	CD, 220pF, 50V, K
C443, 444	22362101	CD, 100pF, 50V, K
C445, 446	22372104	MY, 0.1mfd, 50V, K
C447, 448	22349102	CD, 1000pF, 50V, K
C449, 450	22488479	EL, 4.7mfd, 50V
C451, 452	22349222	CD, 2200pF, 50V, K
C453, 454	22485100	EL, 10mfd, 16V
C455, 456	22485100	EL, 10mfd, 16V
C457, 458	22485100	EL, 10mfd, 16V
C459, 460	22362101	CD, 100pF, 50V, K
C461, 462	22371562	MY, 5600pF, 50V, J
C463, 464	22371472	MY, 4700pF, 50V, J
C465, 466	22371273	MY, 0.027mfd, 50V, J
C467, 468	22371473	MY, 0.047mfd, 50V, J
C469, 470	22485100	EL, 10mfd, 16V
C471, 472	22480003	EL, 0.1mfd, 50V
C473, 474	22480006	EL, 0.33mfd, 50V
C475, 476	22485100	EL, 10mfd, 16V
C477, 478	22485100	EL, 10mfd, 16V
C479, 480	22483101	EL, 100mfd, 10V
C481, 482	22483101	EL, 100mfd, 10V
C484, 485	22488479	EL, 4.7mfd, 50V
C487, 488	22483101	EL, 100mfd, 10V
C489, 490	22488478	EL, 0.47mfd, 50V
C493, 494	22488479	EL, 4.7mfd, 50V
C495, 496	22371153	MY, 0.015mfd, 50V, J
C497	22483470	EL, 47mfd, 10V
C498, 499	22342103	CD, 0.01mfd, 50V, Z
C500	22349103	CD, 0.01mfd, 50V, K
C501, 502	22488109	EL, 1mfd, 50V
C503, 504	22362101	CD, 100pF, 50V, K
C505, 506	22485100	EL, 10mfd, 16V
C507, 508	22371562	MY, 5600pF, 50V, J
C509, 510	22371472	MY, 4700pF, 50V, J
C511, 512	22371273	MY, 0.027mfd, 50V, J
C513, 514	22371473	MY, 0.047mfd, 50V, J
C515, 516	22480003	EL, 0.1mfd, 50V
C517, 518	22480006	EL, 0.33mfd, 50V
C519, 520	22485100	EL, 10mfd, 16V
C521, 522	22485100	EL, 10mfd, 16V

Symbol No.	Part No.	Description
C523, 524	22485100	EL, 10mfd, 16V
C525, 526	22321307	PP, 4700pF, 100V, G
C527, 528	22321309	PP, 235pF, 100V, G
C529, 530	22321308	PP, 9100pF, 100V, G
C531, 532	22321306	PP, 1500pF, 100V, G
C533, 534	22327104	MY, 0.1mfd, 50V, K
C535, 536	22362101	CD, 100pF, 50V, K
C537, 538	22485100	EL, 10mfd, 16V
C539, 540	22361809	CD, 8pF, 50V, D
C541, 542	22349221	CD, 220pF, 50V, K
C543, 544	22362101	CD, 100pF, 50V, K
C545, 546	22349102	CD, 1000pF, 50V, K
C547, 548	22488479	EL, 4.7mfd, 50V
C549, 550	22349222	CD, 2200pF, 50V, K
C551, 552	22485100	EL, 10mfd, 16V
C553, 554	22485100	EL, 10mfd, 16V
C557, 558	22488339	EL, 3.3mfd, 50V
C559, 560	22342103	CD, 0.01mfd, 50V, Z
C561, 562	22342103	CD, 0.01mfd, 50V, Z
C563, 564	22342103	CD, 0.01mfd, 50V, Z
C565, 566	22483101	EL, 100mfd, 10V
C567, 568	22371122	MY, 1200pF, 50V, J
C569, 570	22349821	CD, 820pF, 50V, K
C571, 572	22488339	EL, 3.3mfd, 50V
C573, 574	22483101	EL, 100mfd, 10V
C575	22360484	CD, 0.047mfd, 50V, Z
C601, 602	22488479	EL, 4.7mfd, 50V
C603, 604	22488479	EL, 4.7mfd, 50V
C604, 606	22488479	EL, 4.7mfd, 50V
C607, 608	22480006	EL, 0.33mfd, 50V
C609, 610	22488479	LE, 4.7mfd, 50V
C611, 612	22371182	MY, 1800pF, 50V, J
C613, 614	22372682	MY, 6800pF, 50V, K
C615, 616	22371682	MY, 6800pF, 50V, J
C617, 618	22371332	MY, 3300pF, 50V, J
C619, 620	22371822	MY, 8200pF, 50V, J
C621	22380100	PS, 3300pF, 200V, K
C622	22485330	EL, 3.3mfd, 16V
C623	22371103	MY, 0.01mfd, 50V, J
C624, 625	22349332	CD, 3300pF, 50V, K
C626	22372682	MY, 6800pF, 50V, K
C627, 628	22349332	CD, 3300pF, 50V, K
C629, 630	22349221	CD, 220pF, 50V, K
C631	22380269	PS, 1800pF, 125V, J
C632	EL, 22486220	EL, 22mfd, 25V
C633	22349472	CD, 4700pF, 50V, K
C634	22488479	EL, 4.7mfd, 16V
C635, 636	22485330	EL, 3.3mfd, 16V
C637, 638	22488479	EL, 4.7mfd, 50V

Symbol No.	Part No.	Description
C701	22488339	EL, 3.3mfd, 50V
C702	22488478	EL, 0.47mfd, 50V
C703, 704	22371122	MY, 0.0012mfd, 50V, J
C705	22349391	CD, 390pF, 50V, K
C706, 707	22371332	MY, 0.0033mfd, 50V, J
C709	22440573	EL, 47000mfd, 5.5V
C710	22482102	EL, 1000mfd, 6.3V
C711	22488479	EL, 4.7mfd, 50V
C712	22371333	MY, 0.033mfd, 50V, J
C713, 714	22362101	CD, 100pF, 50V, K
C715	22485330	EL, 3.3mfd, 16V
C716, 717	22342103	CD, 0.01mfd, 50V, Z
C718, 719	22488109	EL, 1mfd, 50V
C720	22488339	EL, 3.3mfd, 50V
C721	22488479	EL, 4.7mfd, 50V
C722	22488109	EL, 1mfd, 50V
C723, 724	22342473	CD, 0.047mfd, 50V, Z
C725, 726	22362101	CD, 100pF, 50V, K
C727	22488108	EL, 0.1mfd, 50V
C728	22488109	EL, 1mfd, 50V
C729, 730	22349102	CD, 1000pF, 50V, K
C731	22488478	EL, 0.47mfd, 50V
C732	22349391	CD, 390pF, 50V, K
C733	22342103	CD, 0.01mfd, 50V, Z
C734	22488339	EL, 3.3mfd, 50V
C735	22488478	EL, 0.47mfd, 50V
C736	22362151	CD, 150pF, 50V, K
C737	22362470	CD, 47pF, 50V, K
△ C901	22340150	CD, 4700pF, 400V, H
△ C902	22483471	EL, 470mfd, 10V
△ C903	22486220	EL, 33mfd, 16V
△ C904	22486220	EL, 2200mfd, 25V
△ C905	22486102	EL, 1000mfd, 15V
△ C906	22486470	EL, 47mfd, 50V
△ C907	22485100	EL, 10mfd, 16V
△ C908	22483101	EL, 100mfd, 10V
C909	22485101	EL, 100mfd, 16V
C910	22485470	EL, 47mfd, 16V
C911	22485471	EL, 470mfd, 16V
C912	22446472	EL, 4700mfd, 25V
C913	22488109	EL, 1mfd, 50V
C914	22440543	EL, 10000mfd, 16V
C915	22486221	EL, 220mfd, 25V
C916	22485330	EL, 3.3mfd, 16V
C917	22362101	CD, 100pF, 50V, K
C918	22485101	EL, 100mfd, 16V
C919	22486221	EL, 220mfd, 25V
C920	22485330	EL, 3.3mfd, 16V
C921	22362101	CD, 100pF, 50V, K
C922	22485100	EL, 10mfd, 16V

Symbol No.	Part No.	Description
RESISTORS		
Resistors are carbon film 1/4W, ±5%, unless otherwise noted. 1K = 1000, 1M = 1000K		
R001	22545225	2.2M ohm
R002, 003	22545101	100 ohm
R004	22545182	1.8K ohm
R101, 102	22545102	1K ohm
R103, 104	22545473	47K ohm
R105, 106	22545563	56K ohm
R107, 108	22545102	1K ohm
R109, 110	22545123	12K ohm
R111, 112	22545151	150 ohm
R113, 114	22545123	12K ohm
R115, 116	22545473	47K ohm
R117, 118	22545104	100K ohm
R121, 122	22545101	100 ohm
R123, 124	22545103	10K ohm
R125, 126	22545473	47K ohm
R129	22545471	470 ohm
R130	22658622	1K ohm, B, Semi-fixed Variable
R131, 132	22545183	18K ohm
R133, 134	22545224	220K ohm
R135	22545474	470K ohm
R136	22545333	33K ohm
R137	22545563	56K ohm
R138	22555563	56K ohm
R139, 140	22545273	27K ohm
R141, 142	22545104	100K ohm
R143, 144	22545102	1K ohm
R145, 146	22545333	33K ohm
R147, 148	22545473	47K ohm
R149, 150	22545103	10K ohm
R151, 152	22545104	100K ohm
R153, 154	22545221	220 ohm
R155, 156	22545332	3.3K ohm
R157	22545225	2.2M ohm
R158	22545103	10K ohm
R159	22545474	470K ohm
R160, 161	22545103	10K ohm
R162	22545103	10K ohm
R163	22545222	2.2K ohm
R164	22545392	3.9K ohm
R165	22545562	5.6K ohm
R166	22555106	10M ohm
R167, 168	22545473	47K ohm
R169, 170	22545473	47K ohm
R171	22545101	100 ohm
R172, 173	22545153	15K ohm
R174	22545153	15K ohm

Symbol No.	Part No.	Description
R175, 176	22545563	56K ohm
R177	22545473	47K ohm
R178	22545222	2.2K ohm
R179, 180	22545223	22K ohm
R181	22545473	47K ohm
R182	22545332	3.3K ohm
R183	22545563	56K ohm
R184	22545471	470 ohm
R185	22545563	56K ohm
R186, 187	22545223	22K ohm
R188	22545223	22K ohm
R190	22555474	470K ohm
R195, 196	22545223	22K ohm
R301	22545224	220K ohm
R302, 303	22545223	22K ohm
R304, 305	22545223	22K ohm
R306, 307	22545223	22K ohm
R308	22545223	22K ohm
R309, 310	22545224	220K ohm
R311, 312	22545224	220K ohm
R313	22545224	220K ohm
R314	22545223	22K ohm
R315, 316	22545223	22K ohm
R317	22545223	22K ohm
R318	22545223	22K ohm
R319	22545105	1M ohm
R320	22545224	220K ohm
R321, 322	22545106	10M ohm
R323	22658603	50K ohm, B, Semi-fixed Variable
R324	22545103	10K ohm
R325	22545273	27K ohm
R327	22658602	5K ohm, B, Semi-fixed Variable
R328	22545273	27K ohm
R329	22545473	47K ohm
R330	22545103	10K ohm
R332, 333	22545103	10K ohm
R335	22545103	10K ohm
R336	22545562	5.6K ohm
R337	22545103	10K ohm
R338	22545273	27K ohm
R339	22555122	1.2K ohm
R340, 341	22545224	220K ohm
R342, 343	22545101	100 ohm
R344, 345	22555102	1K ohm
R348	22545681	680 ohm
R349, 350	22545104	100K ohm
R351, 352	22545473	47K ohm
R353, 354	22658599	10K ohm, B, Semi-fixed Variable

Symbol No.	Part No.	Description
R355, 356	22545223	22K ohm
R357, 358	22545272	2.7K ohm
R359, 380	22545100	10 ohm
R361	22545103	10K ohm
R362	22658599	10K ohm, B, Semi-fixed Variable
R363	22545273	27K ohm
R364	22545104	100K ohm
R365	22545102	1K ohm
R366	22545154	150K ohm
R367, 368	22545223	22K ohm
R369	22545103	10K ohm
R372	22545103	10K ohm
R373, 374	22545225	2.2M ohm
R401, 402	22545221	220 ohm
R403, 404	22545563	56K ohm
R405, 406	22545103	10K ohm
R407, 408	22545103	10K ohm
R409, 410	22545183	18K ohm
R411, 412	22545224	220K ohm
R413, 414	22545103	10K ohm
R415, 416	22658601	500 ohm, B, Semi-fixed Variable
R417, 418	22545472	4.7K ohm
R419, 420	22545472	4.7K ohm
R421, 422	22545473	47K ohm
R423, 424	22545473	47K ohm
R425, 426	22545331	330 ohm
R427, 428	22545104	100K ohm
R429, 430	22545103	10K ohm
R431, 432	22545104	100K ohm
R433, 434	22545104	100K ohm
R435, 436	22545222	2.2K ohm
R437, 438	22545103	10K ohm
R439, 440	22545683	68K ohm
R441, 442	22545473	47K ohm
R443, 444	22545102	1K ohm
R445, 446	22545473	47K ohm
R447, 448	22545224	220K ohm
R449, 450	22545823	82K ohm
R451, 452	22545393	39K ohm
R453, 454	22658603	50K ohm, B, Semi-fixed Variable
R455, 456	22545333	33K ohm
R457, 458	22658603	50K ohm, B, Semi-fixed Variable
R459, 460	22545221	220 ohm
R461, 462	22545224	220K ohm
R463, 464	22545822	8.2K ohm
R465, 466	22555335	3.3M ohm
R467, 468	22545563	56K ohm

Symbol No.	Part No.	Description
R479, 470	22658599	10K ohm, B, Semi-fixed Variable
R471, 472	22545183	18K ohm
R473, 474	22545154	150K ohm
R475, 476	22545274	270K ohm
R477, 478	22545332	3.3K ohm
R479, 480	22545473	47K ohm
R481, 482	22545181	180 ohm
R483, 484	22545473	47K ohm
R485, 486	22658599	10K ohm, B, Semi-fixed Variable
R487, 488	22545106	10M ohm
R489, 490	22545106	10M ohm
R491, 492	22545106	10M ohm
R493, 494	22545473	47K ohm
R495, 496	22550235	2K ohm, ±2%
R497, 498	22545471	470 ohm
R499, 500	22555106	10M ohm
R501, 502	22545104	100K ohm
R503, 504	22545274	270K ohm
R505, 506	22545154	150K ohm
R507, 508	22545332	3.3K ohm
R509, 510	22545473	47K ohm
R511, 512	22545181	180 ohm
R513, 514	22545473	47K ohm
R515, 516	22545222	2.2K ohm
R517, 518	22545222	2.2K ohm
R519, 520	22545563	56K ohm
R521, 522	22545332	3.3K ohm
R523, 524	22545684	680K ohm
R527, 528	22545104	100K ohm
R529, 530	22550235	2K ohm, ±2%
R531, 532	22545473	47K ohm
R533, 534	22545102	1K ohm
R537, 538	22545683	68K ohm
R539, 540	22545473	47K ohm
R541, 542	22545224	220K ohm
R543, 544	22545823	82K ohm
R545, 546	22545221	220 ohm
R547, 548	22545393	39K ohm
R549, 550	22658603	50K ohm, B, Semi-fixed Variable
R551, 552	22545333	33K ohm
R553, 554	22658603	50K ohm, B, Semi-fixed Variable
R555, 556	22545335	3.3K ohm
R557, 558	22545822	8.2K ohm
R559, 560	22545224	220K ohm
R561, 562	22545563	56K ohm
R563, 564	22658599	10K ohm, B, Semi-fixed Variable
R565, 566	22545183	18K ohm
R567, 568	22545106	10M ohm

Symbol No.	Part No.	Description
R569, 570	22545104	100K ohm
R571, 572	22545106	10M ohm
R573, 574	22545106	10M ohm
R575, 576	22545106	10M ohm
R577, 578	22545106	10M ohm
R579, 580	22545106	10M ohm
R581	22545224	220K ohm
R582	22545103	10K ohm
R583, 584	22545224	220K ohm
R585, 586	22545124	120K ohm
R587, 588	22545103	10K ohm
R589, 590	22545224	220K ohm
R591	22545224	220K ohm
R592	22545471	470 ohm
R593, 594	22545102	1K ohm
R595, 596	22545105	1M ohm
R597	22545223	22K ohm
R599, 600	22545105	1M ohm
R601, 602	22555106	10M ohm
R603, 604	22658599	10K ohm, B, Semi-fixed Variable
R605, 606	22545473	47K ohm
R607, 608	22545222	2.2K ohm
R609, 610	22545273	27K ohm
R611, 612	22555824	820K ohm
R613, 614	22545273	27K ohm
R615, 618	22545394	390K ohm
R617, 618	22545273	27K ohm
R619, 620	22545225	2.2M ohm
R621, 622	22545225	2.2M ohm
R623, 624	22545225	2.2M ohm
R625, 626	22545473	47K ohm
R627, 628	22545154	150K ohm
R629, 630	22545103	10K ohm
R631, 632	22545273	27K ohm
R633, 634	22546273	27K ohm
R635, 636	22546683	68K ohm
R637, 638	22545273	27K ohm
R639, 640	22545274	270K ohm
R641, 642	22545274	270K ohm
R643, 644	22545332	3.3K ohm
R645, 646	22545103	10K ohm
R647, 648	22545104	100K ohm
R649, 650	22545271	4.7K ohm
R651, 652	22545221	220 ohm
R653, 654	22545273	27K ohm
R655, 656	22545332	3.3K ohm
R657, 658	22545272	4.7K ohm
R659, 660	22545272	22K ohm
R661, 662	22545103	10K ohm
R663, 664	22545153	15K ohm
R665, 666	22545101	100 ohm
R667, 668	22545223	22K ohm

Symbol No.	Part No.	Description
R669, 670	22545223	22K ohm
R671, 672	22656889	6.8 ohm
R673, 674	22545153	15K ohm
R675, 676	22545330	33 ohm
R677	22545103	10K ohm
R678	22545223	22K ohm
R679	22545104	100K ohm
R680	22545103	10K ohm
R681, 682	22658603	50K ohm, B, Semi-fixed Variable
R683	22500158	1.5K ohm, Fusible
R685	22651579	50K ohm, MN, Variable, Balance
R686	22657269	50K ohm, A, Variable, REC Level
R687, 688	22545473	47K ohm
R689, 690	22545473	47K ohm
R691	22651580	10K ohm, B, Variable, Output
R692	22545103	10K ohm
R693, 694	22545223	22K ohm
R695, 696	22543333	33K ohm
R697, 698	22658280	22K ohm, B, Semi-fixed Variable
R699	22545224	220K ohm
R701	22545103	10K ohm
R702	22545104	100K ohm
R703	22545102	1K ohm
R705, 706	22545224	220K ohm
R707, 708	22545224	220K ohm
R709	22545224	220K ohm
R710	22545104	100K ohm
R711	22545223	22K ohm
R712	22545104	100K ohm
R713	22545472	4.7K ohm
R714	22545104	100K ohm
R715	22545103	10K ohm
R716	22545104	100K ohm
R717	22545473	47K ohm
R718	22545104	100K ohm
R719	22545104	100K ohm
R720	22545332	3.3K ohm
R721	22545332	3.3K ohm
R722, 723	22545104	100K ohm
R724, 725	22545104	100K ohm
R726	22545104	100K ohm
R727	22545223	22K ohm
R728	22545103	10K ohm
R729	22545101	100 ohm
R730	22658599	10K ohm, B, Semi-fixed Variable
R731	22545182	1.8K ohm
R732	22658601	500 ohm, B, Semi-fixed Variable

Symbol No.	Part No.	Description	Symbol No.	Part No.	Description
R733	22545102	1K ohm	R803, 804	22545223	22K ohm
R734	22545103	10K ohm	R805	22545223	22K ohm
R735	22545153	15K ohm	R806, 807	22545103	10K ohm
R736	22545333	33K ohm	R808	22545103	10K ohm
R737	22545224	220K ohm	R809	22545223	22K ohm
R738	22545472	4.7K ohm	R810	22545224	220K ohm
R739	22545183	18K ohm	R811	22545153	15K ohm
R740, 741	22545472	4.7K ohm	R812	22545103	10K ohm
R742, 743	22545473	47K ohm	R813	22545274	270K ohm
R744, 745	22545224	220K ohm	R814, 815	22545104	100K ohm
R746	22545224	220K ohm	R816	22545223	22K ohm
R747	22555471	470 ohm	R817	22545334	330K ohm
R748, 749	22545224	220K ohm	R818	22555102	1K ohm
R750	22545103	10K ohm	R819	22545103	10K ohm
R751	22545223	22K ohm	R820	22545153	15K ohm
R752, 753	22545103	10K ohm	R821	22545103	10K ohm
R754, 755	22545103	10K ohm	R822, 823	22545104	100K ohm
R756, 757	22545103	10K ohm	R824	22545473	47K ohm
R758, 760	22545332	3.3K ohm	R825	22545103	10K ohm
R759, 761	22545223	22K ohm	R826	22545104	100K ohm
R762	22545332	3.3K ohm	R827, 828	22545152	1.5K ohm
R763	22545223	22K ohm	R829, 830	22545152	1.5K ohm
R764, 765	22545473	47K ohm	R831	22545104	100K ohm
R766	22545223	22K ohm	R832	22545103	10K ohm
R767	22547471	470 ohm, 1/2W	R833, 834	22545103	10K ohm
R769	22500176	22 ohm, Fusible	R835, 836	22545104	100K ohm
R769	22547471	470 ohm, 1/2W	R837	22545103	10K ohm
R770	22545102	1K ohm	R838	22545154	150K ohm
R771, 773	22658631	20K ohm, B, Semi-fixed Variable	R839, 840	22545103	10K ohm
R772	22545682	6.8K ohm	R841	22545394	390K ohm
R774	22545472	4.7K ohm	R842	22555223	22K ohm
R775	22545104	100K ohm	R843, 844	22555332	3.3K ohm
R776	22545274	270K ohm	R845	22545104	100K ohm
R777	22545224	220K ohm	R846	22545473	47K ohm
R778, 780	22545104	100K ohm	R847	22545102	1K ohm
R779	22545224	220K ohm	R848	22545223	22K ohm
R781	22545223	22K ohm	R849, 850	22545102	1K ohm
R782	22555155	1.5M ohm	R851	22545102	1K ohm
R783	22555824	820K ohm	R852	22545223	22K ohm
R784	22545104	100K ohm	R853	22570298	18 ohm, 2W, Metal Film
R785	22545103	10K ohm	R854	22545562	5.6K ohm
R786	22545104	100K ohm	R855	22545102	1K ohm
R787, 788	22545473	47K ohm	R856	22545123	12K ohm
R789	22545104	100K ohm	R857	22658599	10K ohm, B, Semi-fixed Variable
R790, 791	22545473	47K ohm	R858	22545472	4.7K ohm
R792, 793	22545473	47K ohm	R859	22500176	22 ohm, Fusible
R794	22545473	47K ohm	R860, 861	22545471	470 ohm
R795	22545104	100K ohm	R862, 864	22545471	470 ohm
R796	22545101	100 ohm	R863, 865	22545223	22K ohm
R797	22545563	56K ohm	R866	22545681	680 ohm
R798	22545103	10K ohm	R867	22545101	100 ohm
R799, 800	22545105	1M ohm	R868	22545181	180 ohm
R801, 802	22545223	22K ohm	R869	22545221	220 ohm

Symbol No.	Part No.	Description	Symbol No.	Part No.	Description
R870, 871	22545181	180 ohm			
R872, 873	22545181	180 ohm			
R874	22545181	180 ohm			
R875	22545221	220 ohm			
R876	22545181	180 ohm			
R877	22545271	270 ohm			
R878, 879	22545151	150 ohm			
R880, 881	22545271	270 ohm			
R882, 883	22545821	820 ohm			
R884	22545181	180 ohm			
R885	22545151	150 ohm			
R886	22545821	820 ohm			
R887	22545104	100K ohm			
R888, 889	22545473	47K ohm			
R890	22645104	100K ohm			
R891	22545223	22K ohm			
R892	22545472	4.7K ohm			
R893	22545223	22K ohm			
R894, 895	22545473	47K ohm			
R896	22545104	100K ohm			
R897, 898	22545225	2.2M ohm			
R899	22545225	2.2M ohm			
R900	22545473	47K ohm			
R901	22500183	3.3 ohm, Fusible			
R902, 903	22500187	2.2 ohm, Fusible			
R904	22547102	1K ohm, 1/2W			
R905	22545101	100 ohm			
R906	22547272	2.7K ohm, 1/2W			
R907	22547681	680 ohm, 1/2W			
R908	22547100	10 ohm, 1/2W			
R909	22545103	10K ohm			
R910	22547471	470 ohm, 1/2W			
R911	22545680	68 ohm			
R912	22545392	3.9K ohm			
R913	22545471	470 ohm			
R914, 915	22545222	2.2K ohm			
R916, 917	22545222	2.2K ohm			
R918	22545102	1K ohm			
R919, 920	22545222	2.2K ohm			
R921, 922	22545222	2.2K ohm			
R923	22545102	1K ohm			
ACCESSORIES					
AC01	22903634	Owner's Manual			
AC02	22990756	Head Cleaner			
AC03	22164775	Connector Cord			

A

B

C

D

E

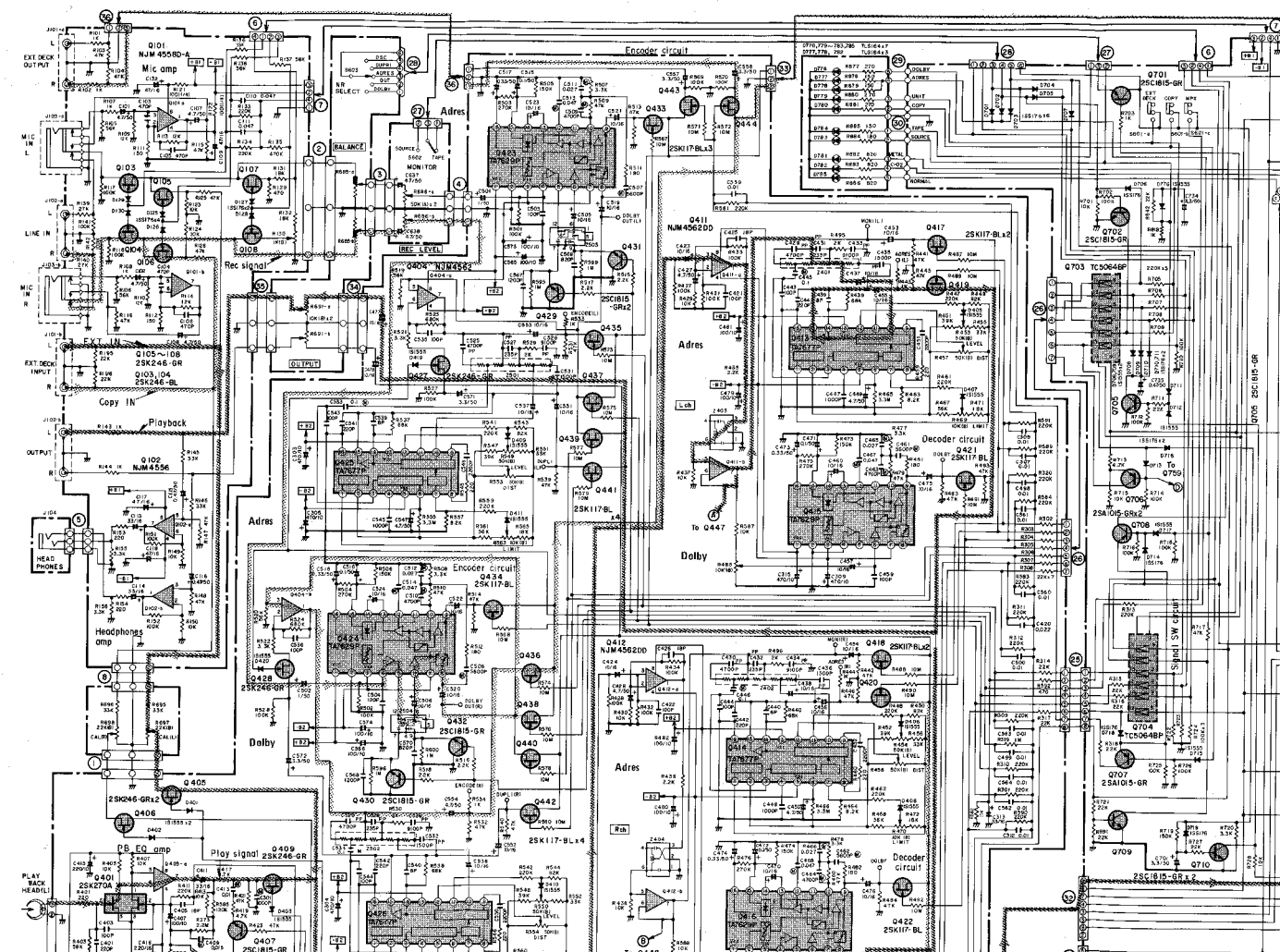

DOWN 25C1815-GR

DOWN 25C1815-GR

DOWN 25C1815-GR

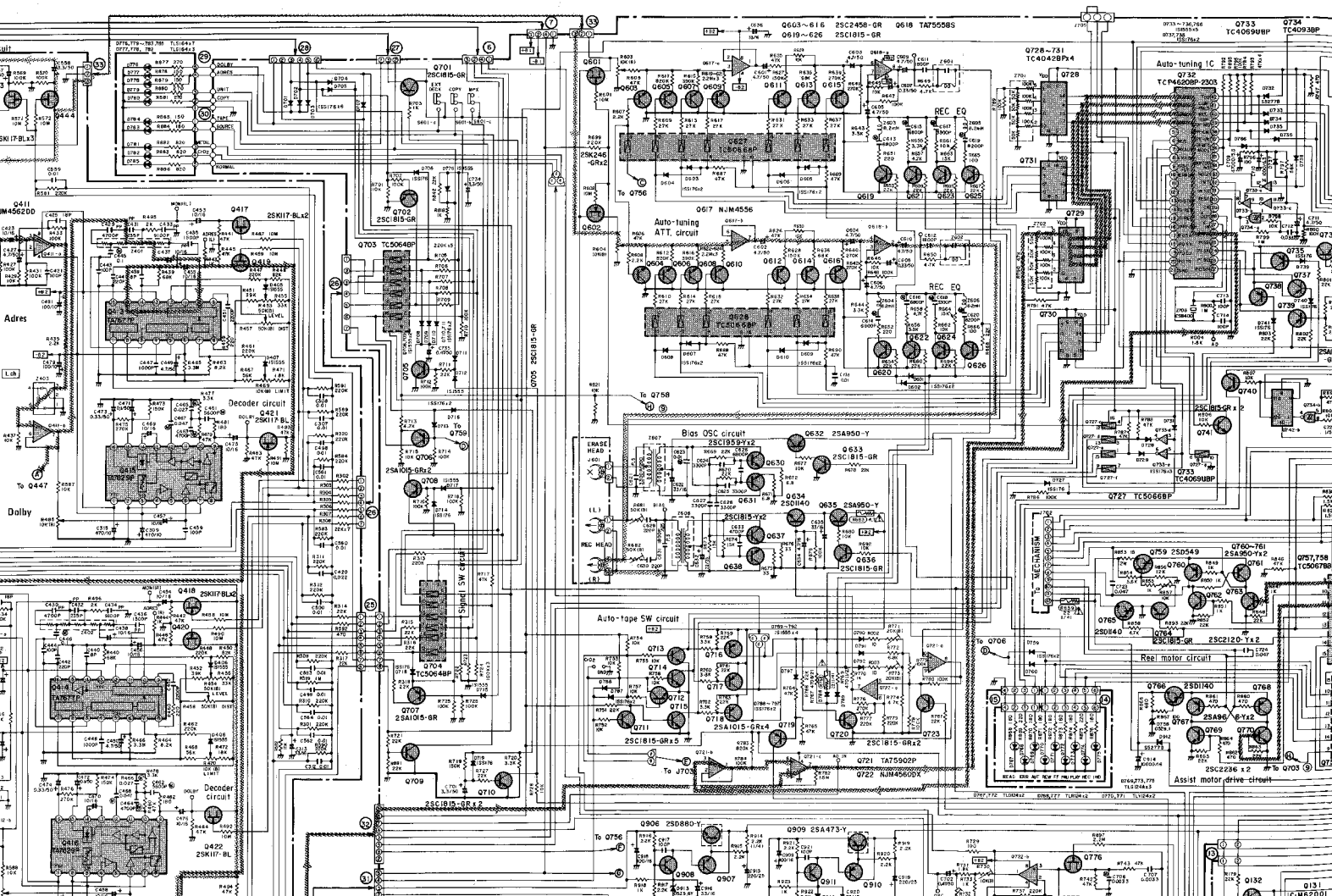

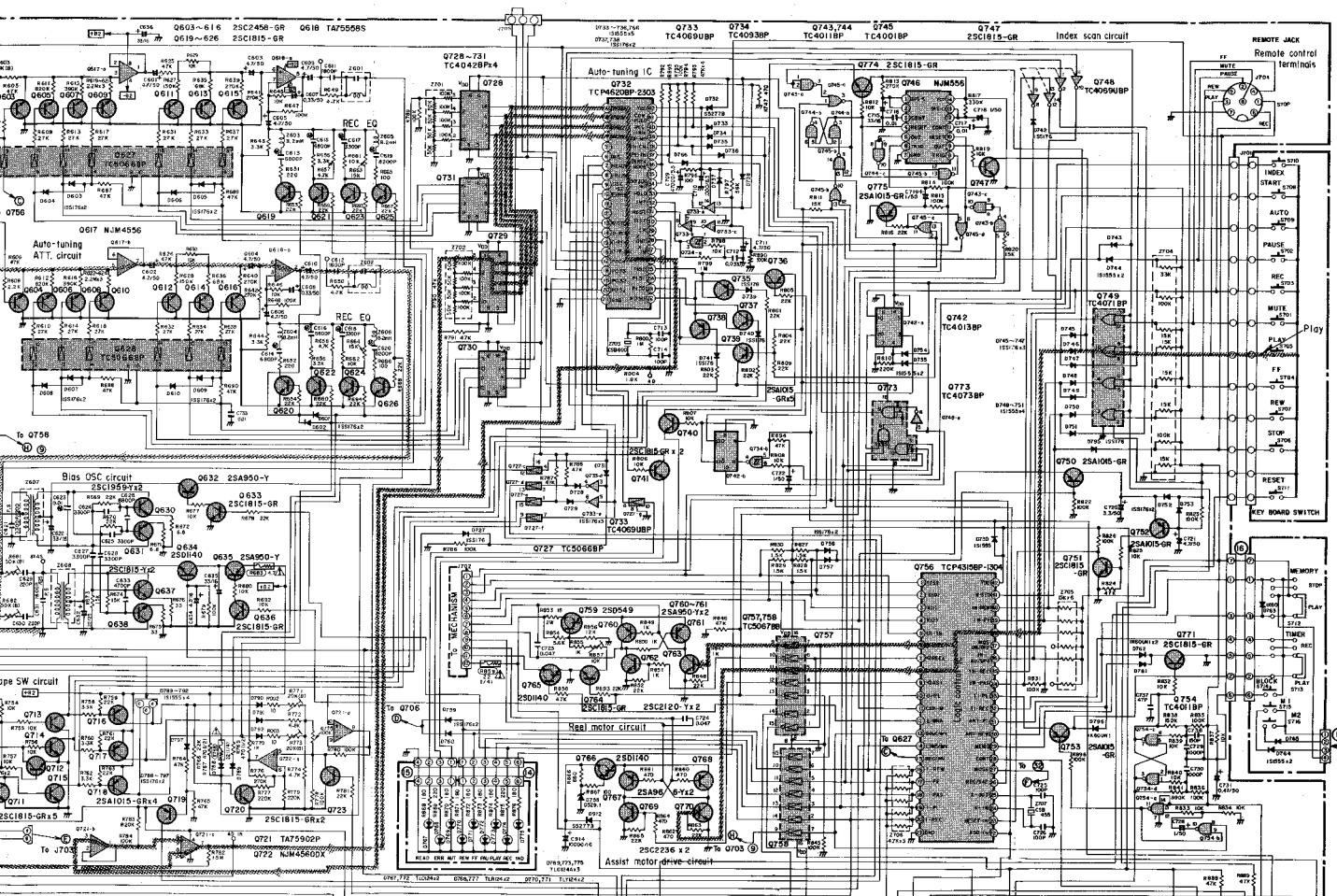

- A
 - B
 - C
 - D
 - E
- 25A950-Y
 - 25A1015-GR
 - 25C1815-GR
 - 25C1959-Y
 - 25C2620-Y
 - 25A966-Y
 - 25C2336-GR
 - 25D1140
 - 25C2458
 - 25A973-Y
 - 25C1733-Y
 - 25D890-Y
 - 25K117-BL
 - 25K246
 - 25D949

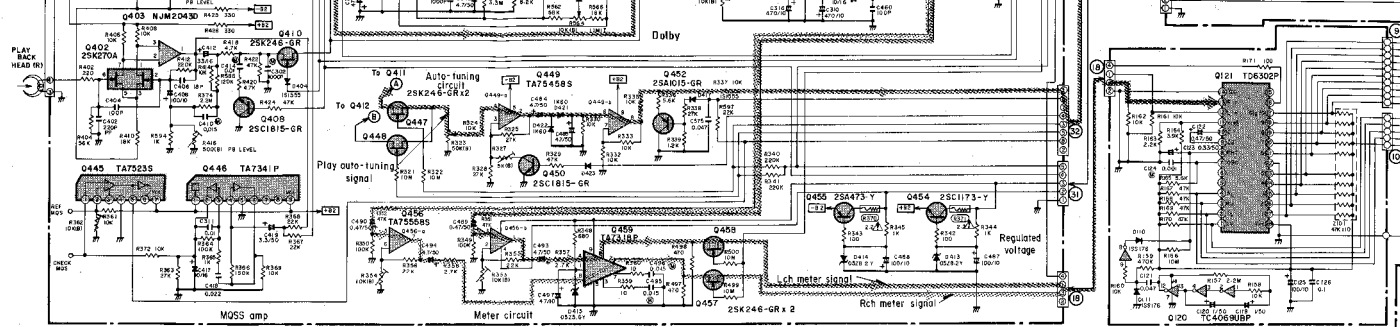

G

SCHEMATIC DIAGRAM (MECHANISM BLOCK)

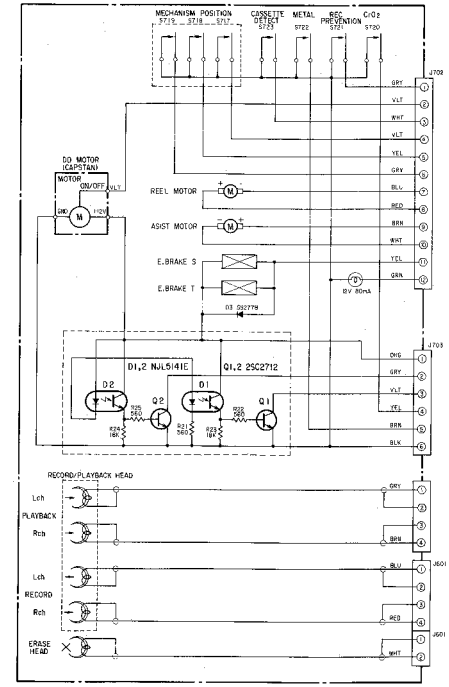

MAIN P.C. Board

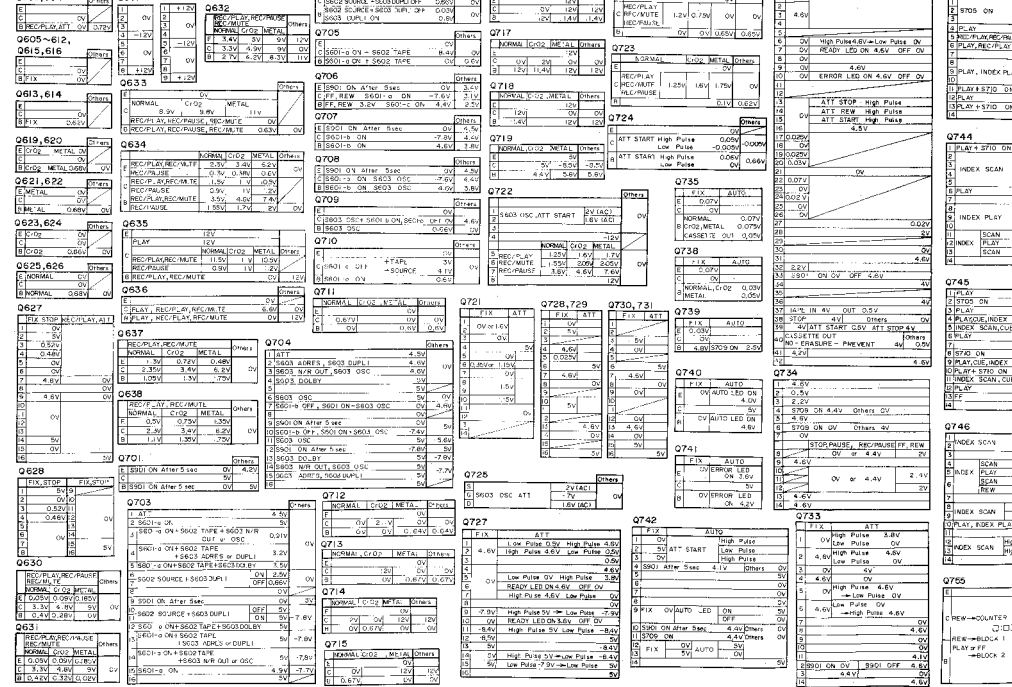

1

2

3

4

5

J

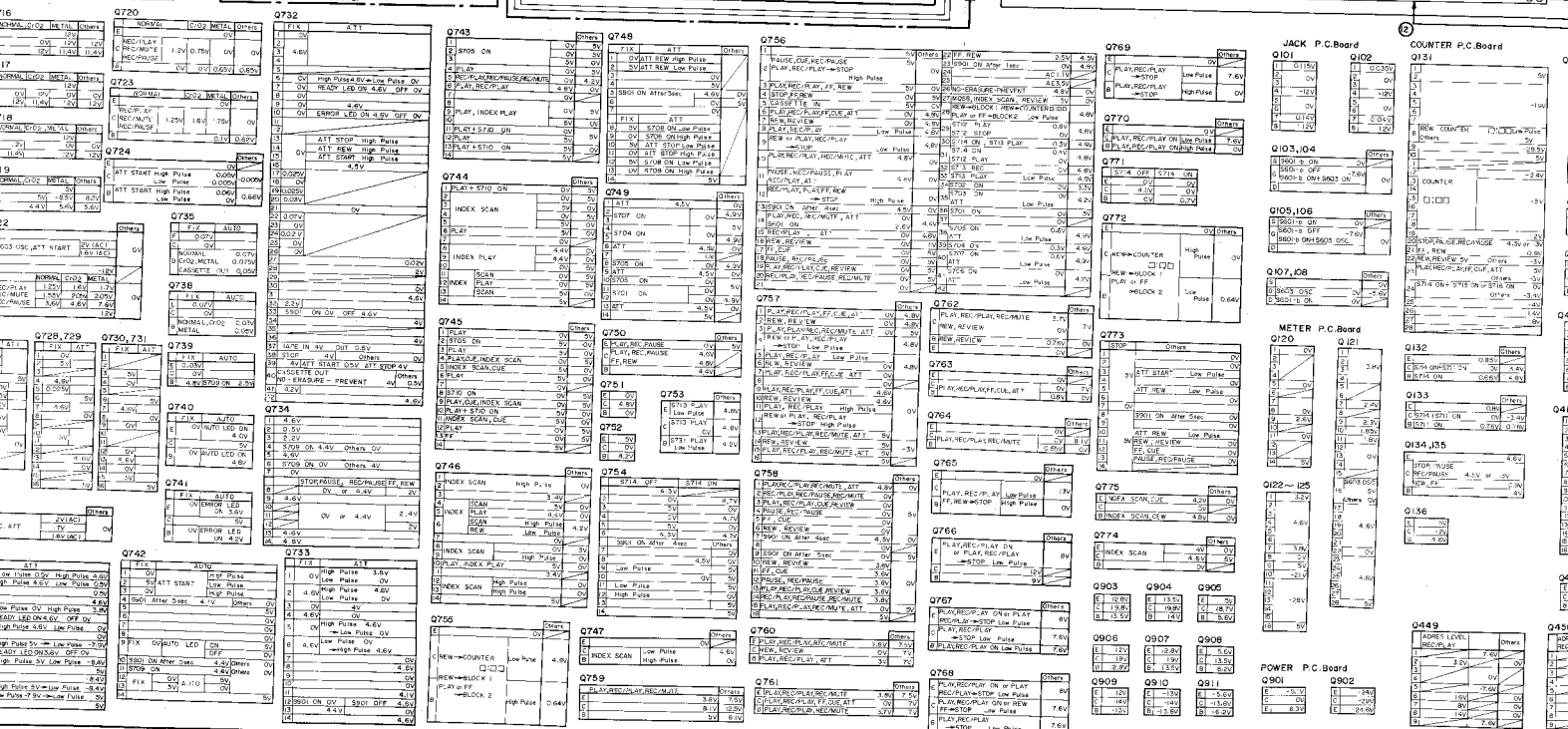
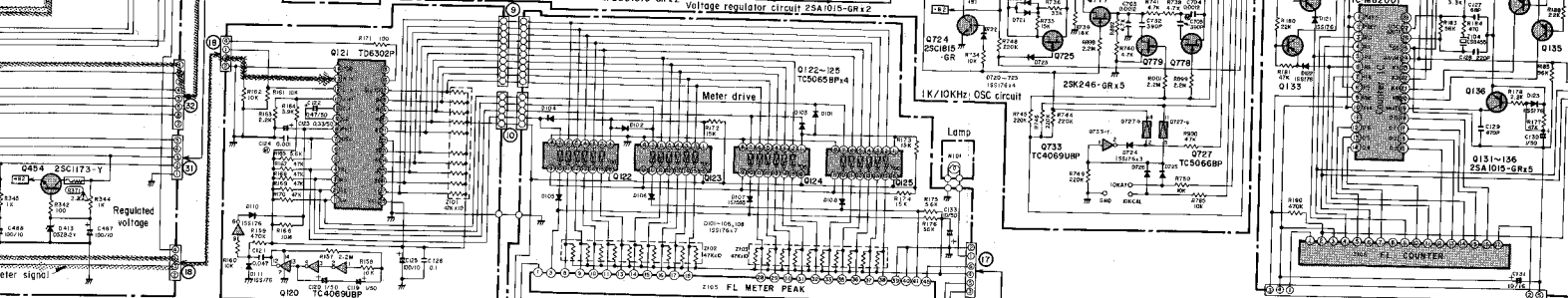

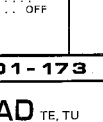
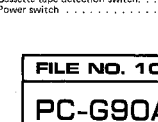
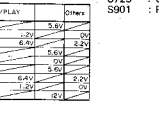
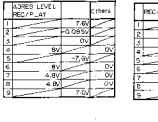
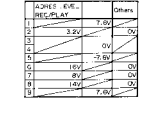
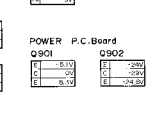
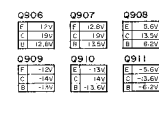
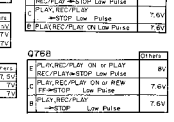
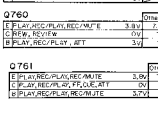
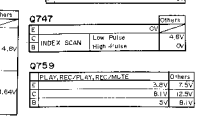
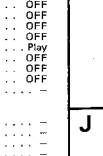
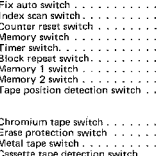
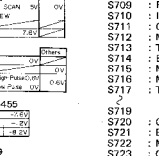
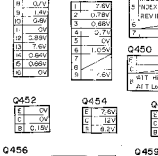
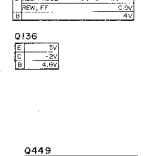
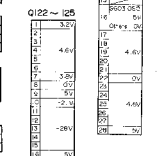
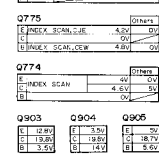
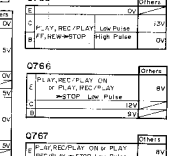
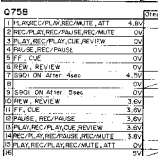
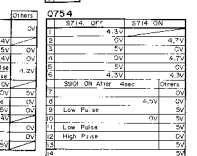
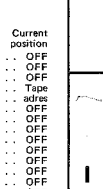
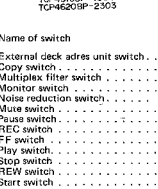
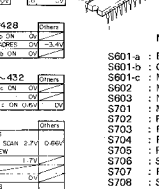
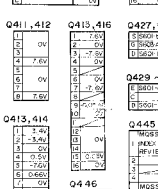
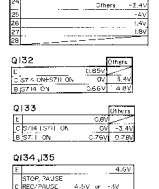
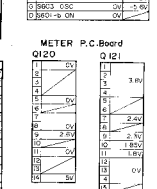
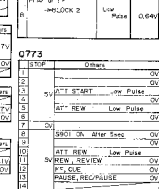
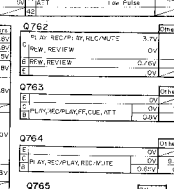
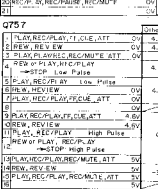
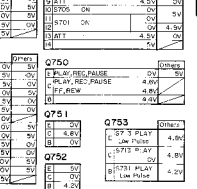
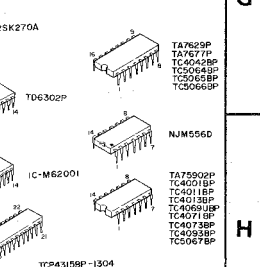
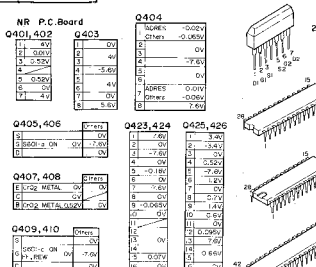
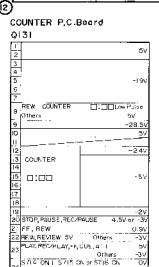
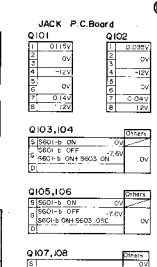
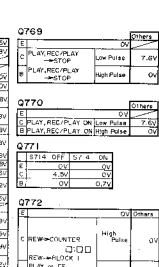
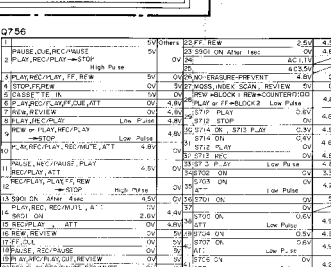
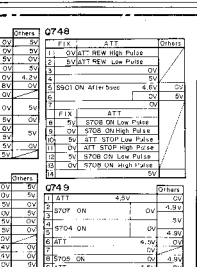
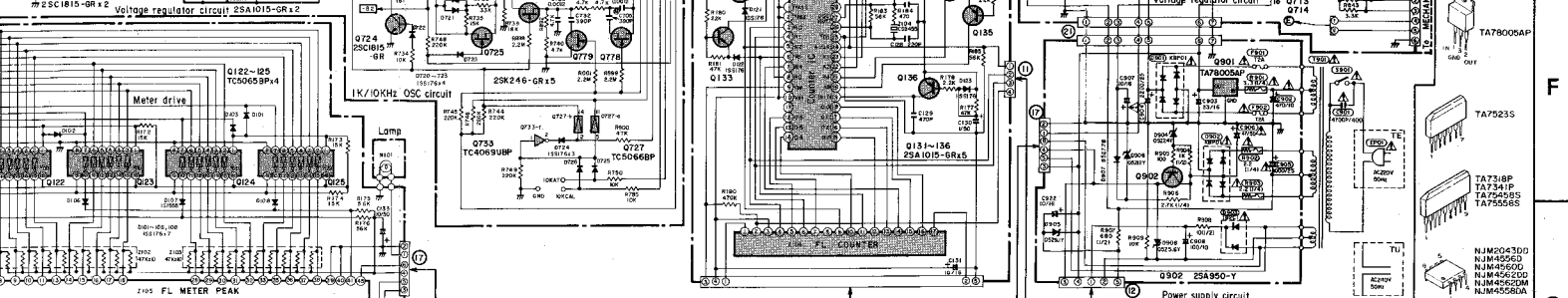

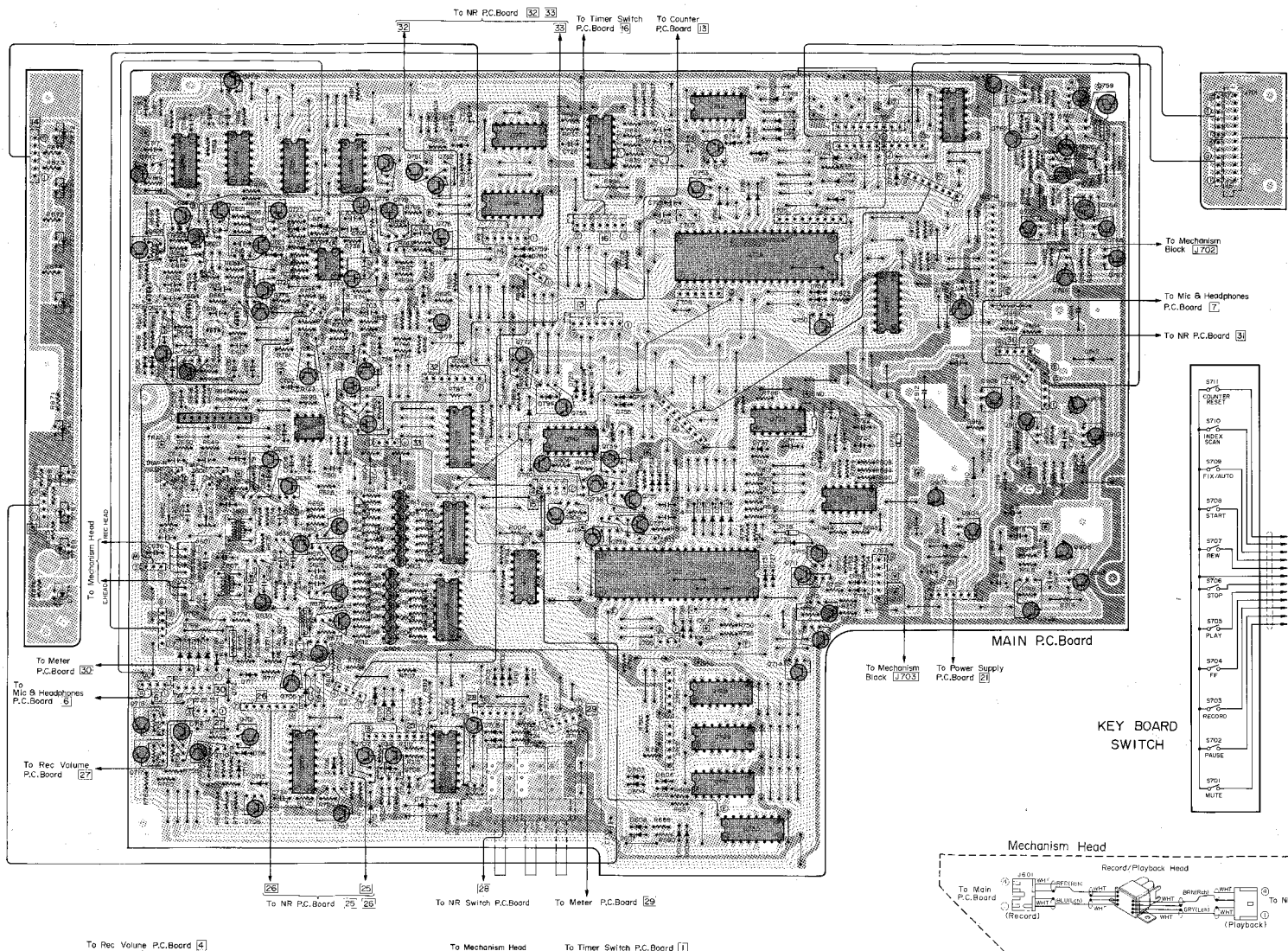

To Rec Volume P.C. Board [2]

To Mechanism Head

To Timer Switch P.C. Board [1]

KEY BOARD SWITCH

Mechanism Head

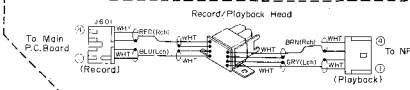

Erase Head

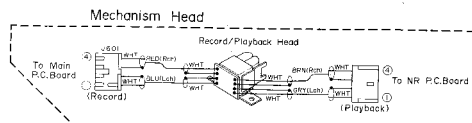
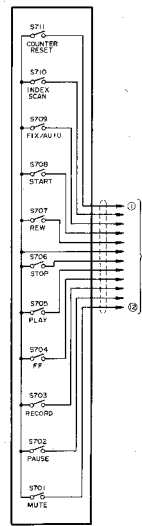
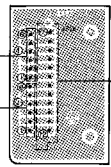
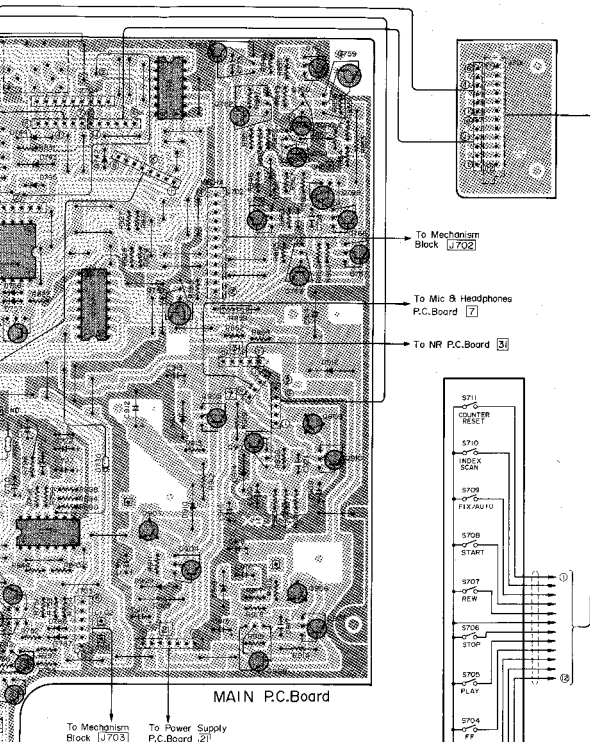

MAIN P.C. Board

Q609, 604	
1	OV
2	OV
3	OV
4	OV
5	OV
6	OV
7	OV
8	OV
9	OV
10	OV
11	OV
12	OV
Q605-612, 615, 616	
1	OV
2	OV
3	OV
4	OV
5	OV
6	OV
7	OV
8	OV
9	OV
10	OV
11	OV
12	OV
Q627	
1	OV
2	OV
3	OV
4	OV
5	OV
6	OV
7	OV
8	OV
9	OV
10	OV
11	OV
12	OV

Q617	
1	OV
2	OV
3	OV
4	OV
5	OV
6	OV
7	OV
8	OV
9	OV
10	OV
11	OV
12	OV

Q618	
1	OV
2	OV
3	OV
4	OV
5	OV
6	OV
7	OV
8	OV
9	OV
10	OV
11	OV
12	OV

Q703	
1	ATT
2	5801-C OV
3	5801-C ON + 5802 TAPE + 5803 S/T/R
4	5801-C ON - 5802 TAPE + 5803 S/T/R
5	5801-C ON - 5802 TAPE + 5803 S/T/R
6	5801-C ON - 5802 TAPE + 5803 S/T/R
7	5801-C ON - 5802 TAPE + 5803 S/T/R
8	5801-C ON - 5802 TAPE + 5803 S/T/R
9	5801-C ON - 5802 TAPE + 5803 S/T/R
10	5801-C ON - 5802 TAPE + 5803 S/T/R
11	5801-C ON - 5802 TAPE + 5803 S/T/R
12	5801-C ON - 5802 TAPE + 5803 S/T/R

Q722	
1	5803 OSC, ATT STAFF
2	5803 OSC, ATT STAFF
3	5803 OSC, ATT STAFF
4	5803 OSC, ATT STAFF
5	5803 OSC, ATT STAFF
6	5803 OSC, ATT STAFF
7	5803 OSC, ATT STAFF
8	5803 OSC, ATT STAFF
9	5803 OSC, ATT STAFF
10	5803 OSC, ATT STAFF
11	5803 OSC, ATT STAFF
12	5803 OSC, ATT STAFF

Q734	
1	4.5V
2	2.5V
3	2.5V
4	STOP ON 4.5V - CHERRY OV
5	STOP ON OV - CHERRY OV
6	STOP ON OV - CHERRY OV
7	STOP ON OV - CHERRY OV
8	STOP ON OV - CHERRY OV
9	STOP ON OV - CHERRY OV
10	STOP ON OV - CHERRY OV
11	STOP ON OV - CHERRY OV
12	STOP ON OV - CHERRY OV

Q749	
1	OV
2	OV
3	OV
4	OV
5	OV
6	OV
7	OV
8	OV
9	OV
10	OV
11	OV
12	OV

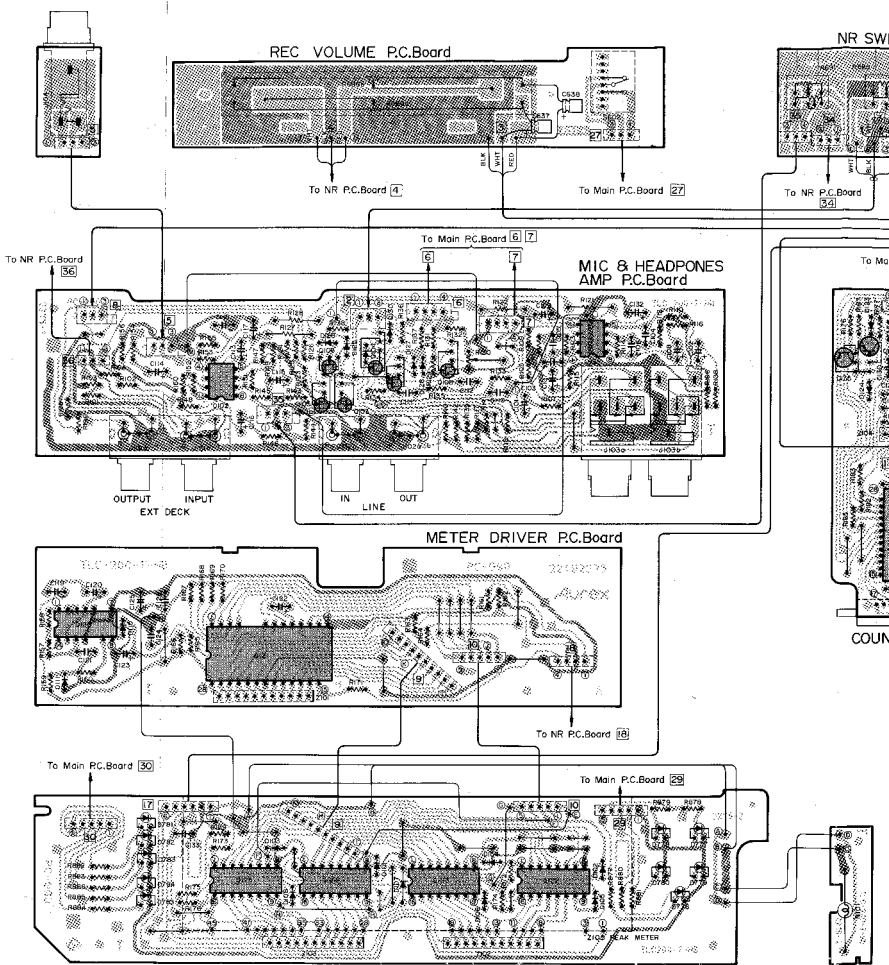

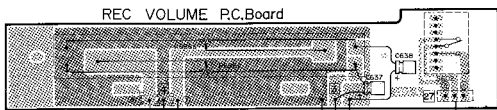
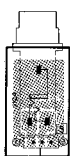

To NR P.C.Board [4]

To Main P.C.Board [27]

NR SWITCH P.C.Board

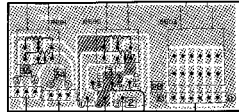

To NR P.C.Board [34]

To Main P.C.Board [28]

TIMER SWITCH P.C.Board

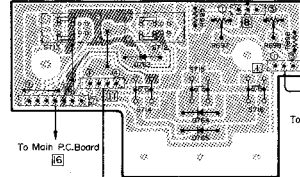

To Main P.C.Board [6]

To NR P.C.Board [1]

To NR P.C.Board [36]

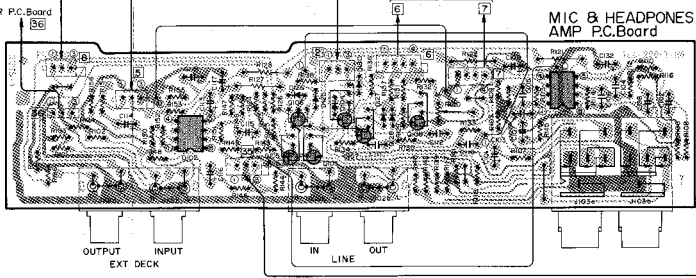

OUTPUT
EXT DECK

INPUT

To Main P.C.Board [6]

To Main P.C.Board [7]

MIC & HEADPHONES
AMP P.C.Board

IN LINE OUT

To Main P.C.Board [23]

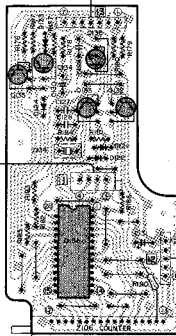

COUNTER P.C.Board

POWER SUPPLY P.C.Board

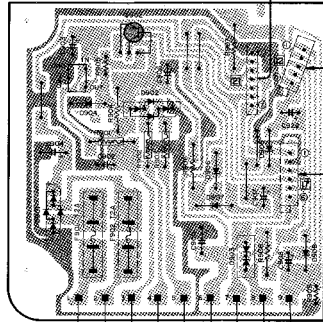

To Main P.C.Board [21]

RED RED B.L.F. V.L. V.L. GRK. B.L.U. B.L.N.

METER DRIVER P.C.Board

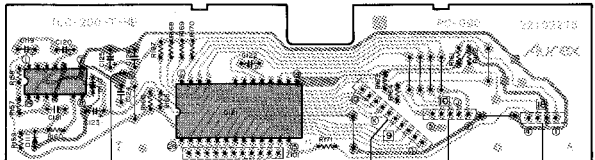

To NR P.C.Board [18]

To Main P.C.Board [30]

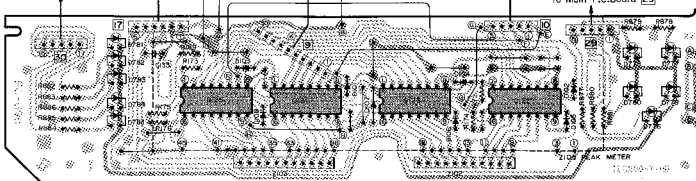

METER P.C.Board

To Main P.C.Board [29]

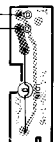

MAIN P.C.Board

Q603,604

1	4.5V	OV
2	REC/PLAY	OV
3	REC/PLAY	OV
4	REC/PLAY	OV
5	REC/PLAY	OV
6	REC/PLAY	OV
7	REC/PLAY	OV
8	REC/PLAY	OV
9	REC/PLAY	OV
10	REC/PLAY	OV
11	REC/PLAY	OV
12	REC/PLAY	OV
13	REC/PLAY	OV
14	REC/PLAY	OV
15	REC/PLAY	OV
16	REC/PLAY	OV
17	REC/PLAY	OV
18	REC/PLAY	OV
19	REC/PLAY	OV
20	REC/PLAY	OV

Q605 - Q612, Q615, 616

1	4.5V	OV
2	REC/PLAY	OV
3	REC/PLAY	OV
4	REC/PLAY	OV
5	REC/PLAY	OV
6	REC/PLAY	OV
7	REC/PLAY	OV
8	REC/PLAY	OV
9	REC/PLAY	OV
10	REC/PLAY	OV
11	REC/PLAY	OV
12	REC/PLAY	OV
13	REC/PLAY	OV
14	REC/PLAY	OV
15	REC/PLAY	OV
16	REC/PLAY	OV
17	REC/PLAY	OV
18	REC/PLAY	OV
19	REC/PLAY	OV
20	REC/PLAY	OV

Q617

1	4.5V	OV
2	REC/PLAY	OV
3	REC/PLAY	OV
4	REC/PLAY	OV
5	REC/PLAY	OV
6	REC/PLAY	OV
7	REC/PLAY	OV
8	REC/PLAY	OV
9	REC/PLAY	OV
10	REC/PLAY	OV
11	REC/PLAY	OV
12	REC/PLAY	OV
13	REC/PLAY	OV
14	REC/PLAY	OV
15	REC/PLAY	OV
16	REC/PLAY	OV
17	REC/PLAY	OV
18	REC/PLAY	OV
19	REC/PLAY	OV
20	REC/PLAY	OV

Q618

1	4.5V	OV
2	REC/PLAY	OV
3	REC/PLAY	OV
4	REC/PLAY	OV
5	REC/PLAY	OV
6	REC/PLAY	OV
7	REC/PLAY	OV
8	REC/PLAY	OV
9	REC/PLAY	OV
10	REC/PLAY	OV
11	REC/PLAY	OV
12	REC/PLAY	OV
13	REC/PLAY	OV
14	REC/PLAY	OV
15	REC/PLAY	OV
16	REC/PLAY	OV
17	REC/PLAY	OV
18	REC/PLAY	OV
19	REC/PLAY	OV
20	REC/PLAY	OV

Q703

1	4.5V	OV
2	REC/PLAY	OV
3	REC/PLAY	OV
4	REC/PLAY	OV
5	REC/PLAY	OV
6	REC/PLAY	OV
7	REC/PLAY	OV
8	REC/PLAY	OV
9	REC/PLAY	OV
10	REC/PLAY	OV
11	REC/PLAY	OV
12	REC/PLAY	OV
13	REC/PLAY	OV
14	REC/PLAY	OV
15	REC/PLAY	OV
16	REC/PLAY	OV
17	REC/PLAY	OV
18	REC/PLAY	OV
19	REC/PLAY	OV
20	REC/PLAY	OV

Others

1	4.5V	OV
2	REC/PLAY	OV
3	REC/PLAY	OV
4	REC/PLAY	OV
5	REC/PLAY	OV
6	REC/PLAY	OV
7	REC/PLAY	OV
8	REC/PLAY	OV
9	REC/PLAY	OV
10	REC/PLAY	OV
11	REC/PLAY	OV
12	REC/PLAY	OV
13	REC/PLAY	OV
14	REC/PLAY	OV
15	REC/PLAY	OV
16	REC/PLAY	OV
17	REC/PLAY	OV
18	REC/PLAY	OV
19	REC/PLAY	OV
20	REC/PLAY	OV

Q722

1	4.5V	OV
2	REC/PLAY	OV
3	REC/PLAY	OV
4	REC/PLAY	OV
5	REC/PLAY	OV
6	REC/PLAY	OV
7	REC/PLAY	OV
8	REC/PLAY	OV
9	REC/PLAY	OV
10	REC/PLAY	OV
11	REC/PLAY	OV
12	REC/PLAY	OV
13	REC/PLAY	OV
14	REC/PLAY	OV
15	REC/PLAY	OV
16	REC/PLAY	OV
17	REC/PLAY	OV
18	REC/PLAY	OV
19	REC/PLAY	OV
20	REC/PLAY	OV

Q734

1	4.5V	OV
2	REC/PLAY	OV
3	REC/PLAY	OV
4	REC/PLAY	OV
5	REC/PLAY	OV
6	REC/PLAY	OV
7	REC/PLAY	OV
8	REC/PLAY	OV
9	REC/PLAY	OV
10	REC/PLAY	OV
11	REC/PLAY	OV
12	REC/PLAY	OV
13	REC/PLAY	OV
14	REC/PLAY	OV
15	REC/PLAY	OV
16	REC/PLAY	OV
17	REC/PLAY	OV
18	REC/PLAY	OV
19	REC/PLAY	OV
20	REC/PLAY	OV

Q748

1	4.5V	OV
2	REC/PLAY	OV
3	REC/PLAY	OV
4	REC/PLAY	OV
5	REC/PLAY	OV
6	REC/PLAY	OV
7	REC/PLAY	OV
8	REC/PLAY	OV
9	REC/PLAY	OV
10	REC/PLAY	OV
11	REC/PLAY	OV
12	REC/PLAY	OV
13	REC/PLAY	OV
14	REC/PLAY	OV
15	REC/PLAY	OV
16	REC/PLAY	OV
17	REC/PLAY	OV
18	REC/PLAY	OV
19	REC/PLAY	OV
20	REC/PLAY	OV

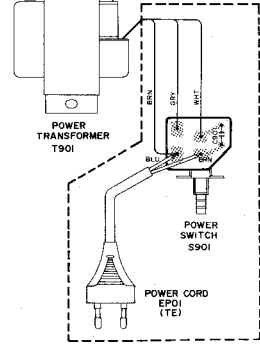
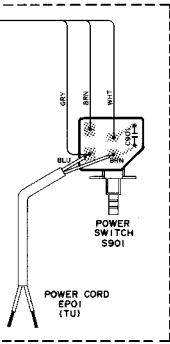

Q758

1	4.5V	OV
2	REC/PLAY	OV
3	REC/PLAY	OV
4	REC/PLAY	OV
5	REC/PLAY	OV
6	REC/PLAY	OV
7	REC/PLAY	OV
8	REC/PLAY	OV
9	REC/PLAY	OV
10	REC/PLAY	OV
11	REC/PLAY	OV
12	REC/PLAY	OV
13	REC/PLAY	OV
14	REC/PLAY	OV
15	REC/PLAY	OV
16	REC/PLAY	OV
17	REC/PLAY	OV
18	REC/PLAY	OV
19	REC/PLAY	OV
20	REC/PLAY	OV

Q131

1	4.5V	OV
2	REC/PLAY	OV
3	REC/PLAY	OV
4	REC/PLAY	OV
5	REC/PLAY	OV
6	REC/PLAY	OV
7	REC/PLAY	OV
8	REC/PLAY	OV
9	REC/PLAY	OV
10	REC/PLAY	OV
11	REC/PLAY	OV
12	REC/PLAY	OV
13	REC/PLAY	OV
14	REC/PLAY	OV
15	REC/PLAY	OV
16	REC/PLAY	OV
17	REC/PLAY	OV
18	REC/PLAY	OV
19	REC/PLAY	OV
20	REC/PLAY	OV

Q132

1	4.5V	OV
2	REC/PLAY	OV
3	REC/PLAY	OV
4	REC/PLAY	OV
5	REC/PLAY	OV
6	REC/PLAY	OV
7	REC/PLAY	OV
8	REC/PLAY	OV
9	REC/PLAY	OV
10	REC/PLAY	OV
11	REC/PLAY	OV
12	REC/PLAY	OV
13	REC/PLAY	OV
14	REC/PLAY	OV
15	REC/PLAY	OV
16	REC/PLAY	OV
17	REC/PLAY	OV
18	REC/PLAY	OV
19	REC/PLAY	OV
20	REC/PLAY	OV

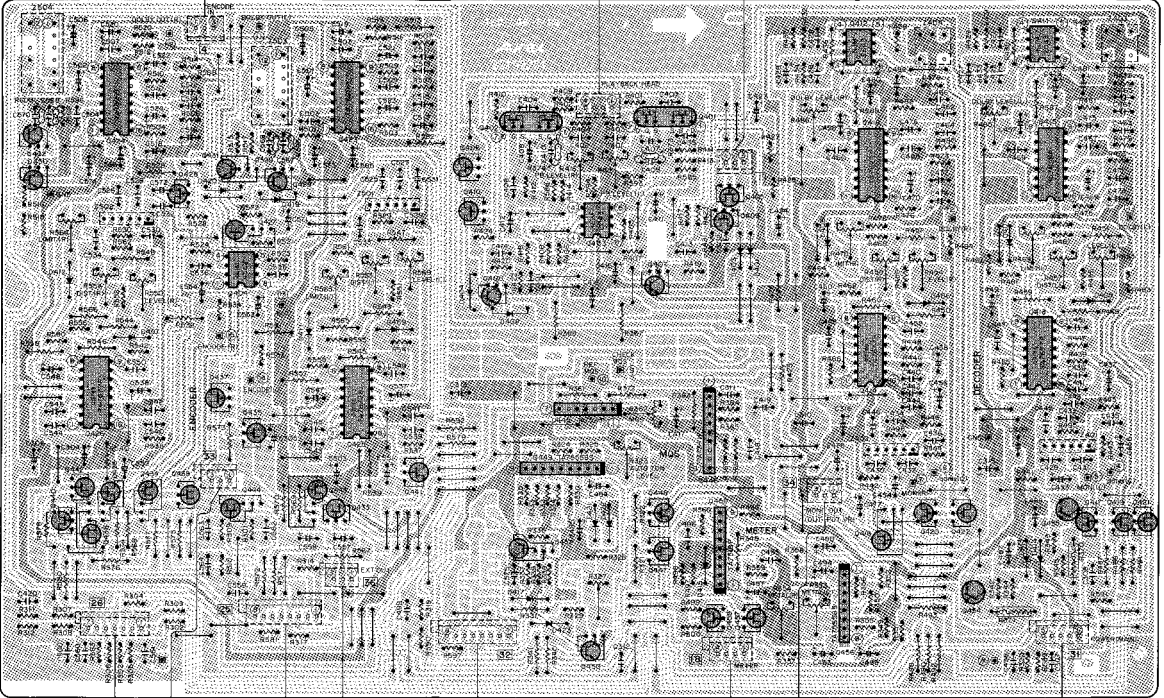

[26] [33] To Main P.C.Board [25] To Mic & Headphones Amp P.C.Board [36]
 To Main P.C.Board [32] To Meter Driver P.C.Board [8] To NR Switch P.C.Board [34] To Main P.C.Board [31]

NR P.C.Board

Q401, 402

1	4V
2	0.001
3	0.02
4	0
5	0.02
6	0V
7	4.2

Q403

1	0V
2	46
3	15.8K
4	0V
5	44
6	0V
7	5.5V

Q404

1	0.005
2	0.005
3	0V
4	0V
5	0V
6	0V
7	0V

Q405, 406

1	0.005
2	0.005
3	0V
4	0V
5	0V
6	0V
7	0V

Q407, 408

1	0.005
2	0.005
3	0V
4	0V
5	0V
6	0V
7	0V

Q409, 410

1	0.005
2	0.005
3	0V
4	0V
5	0V
6	0V
7	0V

Q411, 412

1	0V
2	3.5V
3	0V
4	0V
5	0V
6	0V
7	0V

Q413, 414

1	1.75V
2	0V
3	0V
4	0V
5	0V
6	0V
7	0V

Q415, 416

1	1.75V
2	0V
3	0V
4	0V
5	0V
6	0V
7	0V

Q423, 424

1	0.005
2	0.005
3	0V
4	0V
5	0V
6	0V
7	0V

Q425, 426

1	0.005
2	0.005
3	0V
4	0V
5	0V
6	0V
7	0V

Q427, 428

1	0.005
2	0.005
3	0V
4	0V
5	0V
6	0V
7	0V

Q429 - 432

1	0V
2	0V
3	0V
4	0V
5	0V
6	0V
7	0V

Q445

1	0.005
2	0.005
3	0V
4	0V
5	0V
6	0V
7	0V

Q449

1	0.005
2	0.005
3	0V
4	0V
5	0V
6	0V
7	0V

Q446

1	0.005
2	0.005
3	0V
4	0V
5	0V
6	0V
7	0V

Q450

1	0.005
2	0.005
3	0V
4	0V
5	0V
6	0V
7	0V

Q452

1	0.005
2	0.005
3	0V
4	0V
5	0V
6	0V
7	0V

Q456

1	0.005
2	0.005
3	0V
4	0V
5	0V
6	0V
7	0V

Q454

1	0.005
2	0.005
3	0V
4	0V
5	0V
6	0V
7	0V

Q455

1	0.005
2	0.005
3	0V
4	0V
5	0V
6	0V
7	0V

Q459

1	0.005
2	0.005
3	0V
4	0V
5	0V
6	0V
7	0V

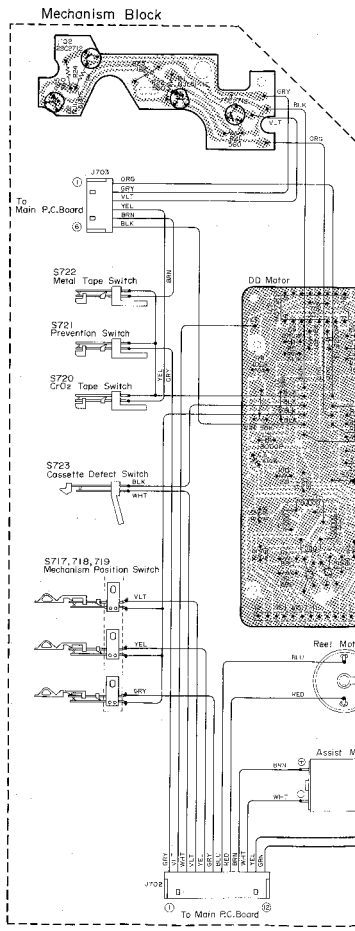

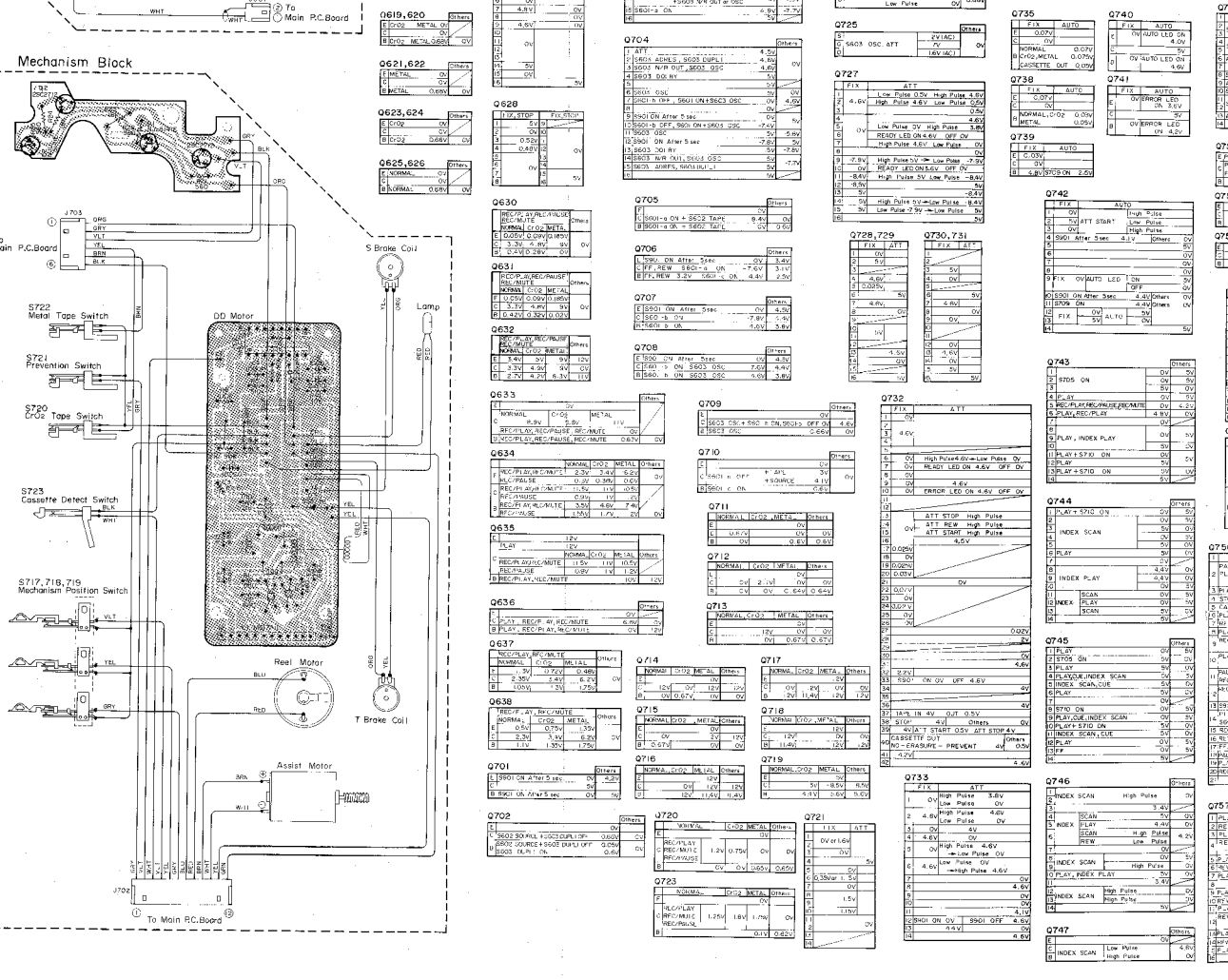

U613, 614 Others

F	4.0V	OV
G	OV	OV
H	OV	OV
I	OV	OV

0619, 620 Others

D	4.8V	OV
E	OV	OV
F	OV	OV
G	OV	OV
H	OV	OV
I	OV	OV

0621, 622 Others

D	4.8V	OV
E	OV	OV
F	OV	OV
G	OV	OV
H	OV	OV
I	OV	OV

0623, 624 Others

D	4.8V	OV
E	OV	OV
F	OV	OV
G	OV	OV
H	OV	OV
I	OV	OV

0625, 626 Others

D	4.8V	OV
E	OV	OV
F	OV	OV
G	OV	OV
H	OV	OV
I	OV	OV

0628 Others

F	4.8V	OV
G	OV	OV
H	OV	OV
I	OV	OV

0630 Others

F	4.8V	OV
G	OV	OV
H	OV	OV
I	OV	OV

0631 Others

F	4.8V	OV
G	OV	OV
H	OV	OV
I	OV	OV

0632 Others

F	4.8V	OV
G	OV	OV
H	OV	OV
I	OV	OV

0633 Others

F	4.8V	OV
G	OV	OV
H	OV	OV
I	OV	OV

0634 Others

F	4.8V	OV
G	OV	OV
H	OV	OV
I	OV	OV

0635 Others

F	4.8V	OV
G	OV	OV
H	OV	OV
I	OV	OV

0636 Others

F	4.8V	OV
G	OV	OV
H	OV	OV
I	OV	OV

0637 Others

F	4.8V	OV
G	OV	OV
H	OV	OV
I	OV	OV

0638 Others

F	4.8V	OV
G	OV	OV
H	OV	OV
I	OV	OV

0639 Others

F	4.8V	OV
G	OV	OV
H	OV	OV
I	OV	OV

0701 Others

F	4.8V	OV
G	OV	OV
H	OV	OV
I	OV	OV

0702 Others

F	4.8V	OV
G	OV	OV
H	OV	OV
I	OV	OV

0703 Others

F	4.8V	OV
G	OV	OV
H	OV	OV
I	OV	OV

0704 Others

F	4.8V	OV
G	OV	OV
H	OV	OV
I	OV	OV

0705 Others

F	4.8V	OV
G	OV	OV
H	OV	OV
I	OV	OV

0706 Others

F	4.8V	OV
G	OV	OV
H	OV	OV
I	OV	OV

0707 Others

F	4.8V	OV
G	OV	OV
H	OV	OV
I	OV	OV

0708 Others

F	4.8V	OV
G	OV	OV
H	OV	OV
I	OV	OV

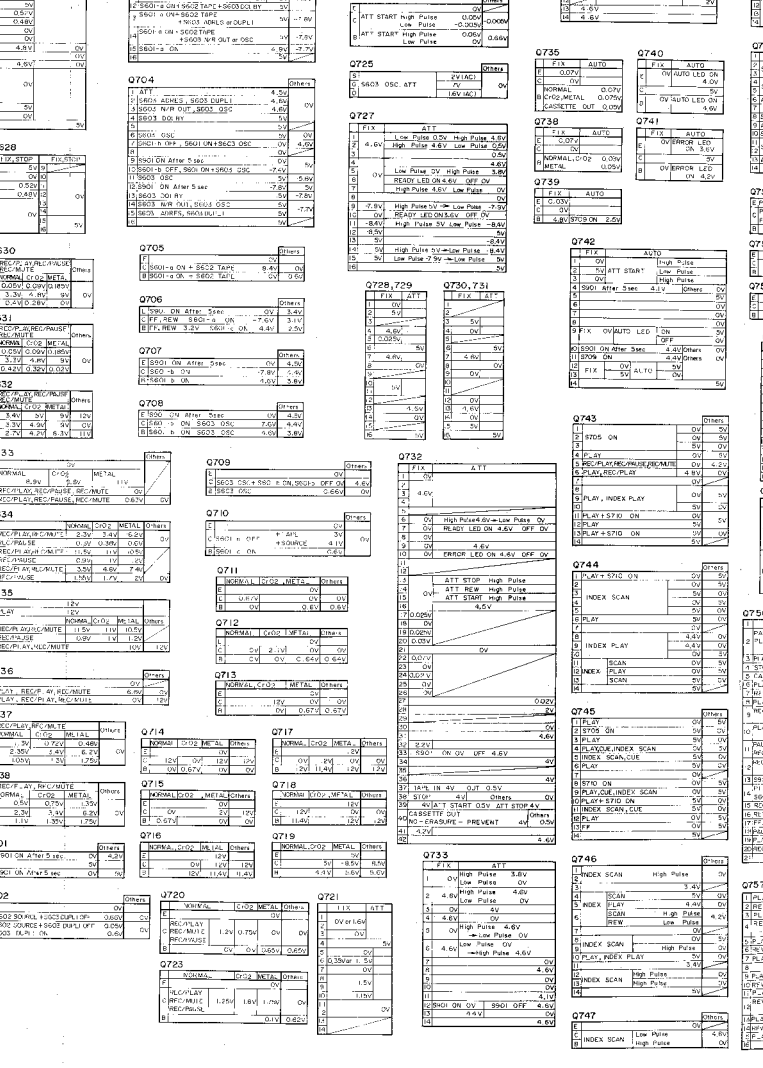

U454 Others

C	2.0V	OV
D	OV	OV
E	OV	OV
F	OV	OV
G	OV	OV
H	OV	OV
I	OV	OV

U455 Others

C	2.0V	OV
D	OV	OV
E	OV	OV
F	OV	OV
G	OV	OV
H	OV	OV
I	OV	OV

U456 Others

C	2.0V	OV
D	OV	OV
E	OV	OV
F	OV	OV
G	OV	OV
H	OV	OV
I	OV	OV

